

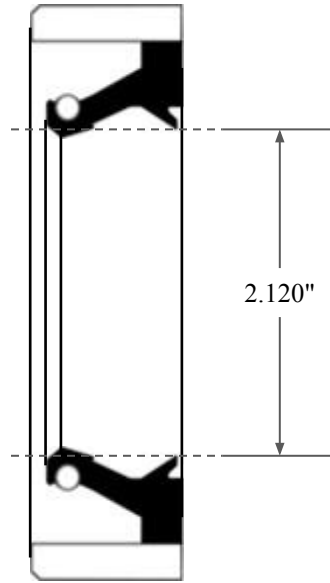

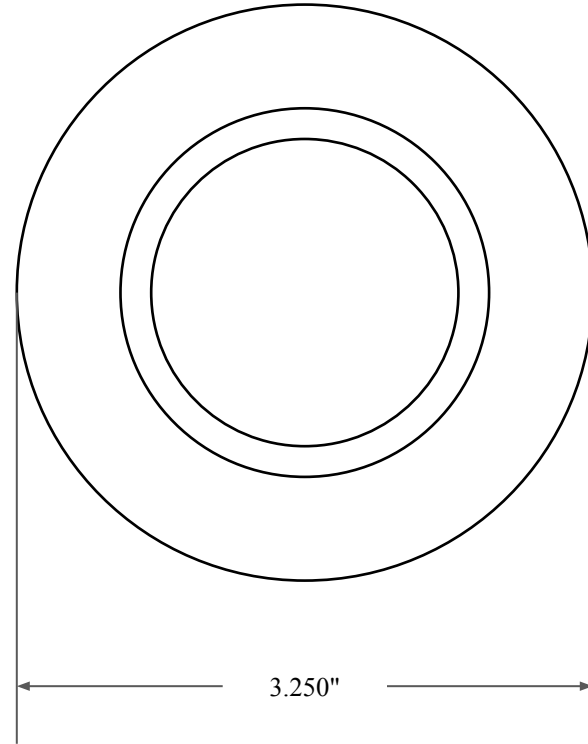

0.438"



2.120"



3.250"

 GLOBAL O-RING and SEAL ALL-AROUND BETTER	PART NUMBER FRS7900CV90
14450 John F. Kennedy Blvd. Houston, TX 77032 www.globaloring.com	Fabric Reinforced Oil Seal - Viton 90 Style C Ref: JM Clipper 16468 HSL16
Information in this drawing is provided for reference only	