

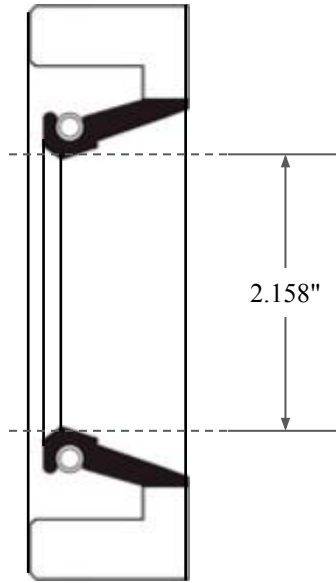

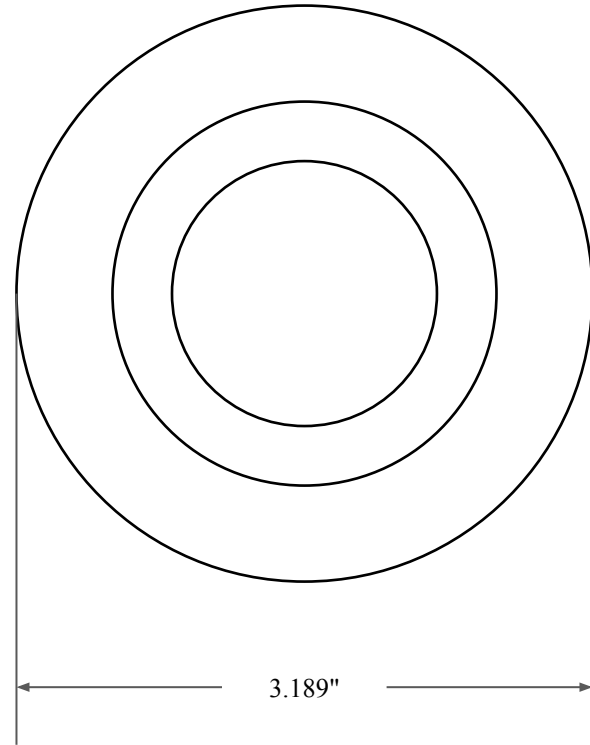

0.500"



2.158"



3.189"

| | |
|---|---|
|  GLOBAL O-RING and SEAL ALL-AROUND BETTER | PART NUMBER FRS8082A |
| 14450 John F. Kennedy Blvd. Houston, TX 77032 www.globaloring.com | Fabric Reinforced Oil Seal - Nitrile 90 Style A Ref: JM Clipper 18406 H1L5 |
| Information in this drawing is provided for reference only | |