

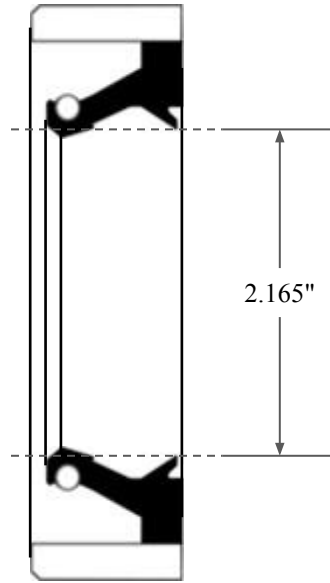



0.315"



2.165"



2.736"

 GLOBAL O-RING and SEAL ALL-AROUND BETTER	PART NUMBER FRS8099CV90
14450 John F. Kennedy Blvd. Houston, TX 77032	Fabric Reinforced Oil Seal - Viton 90 Style C Ref: JM Clipper 20656 HSL16
Information in this drawing is provided for reference only	