

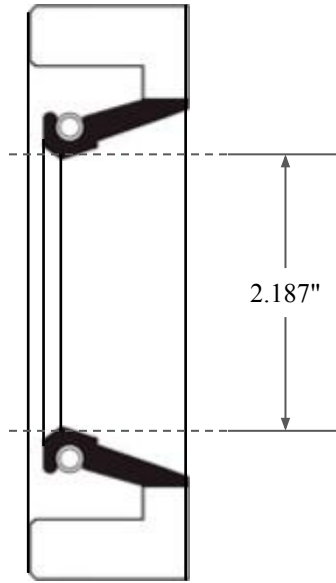

0.375"

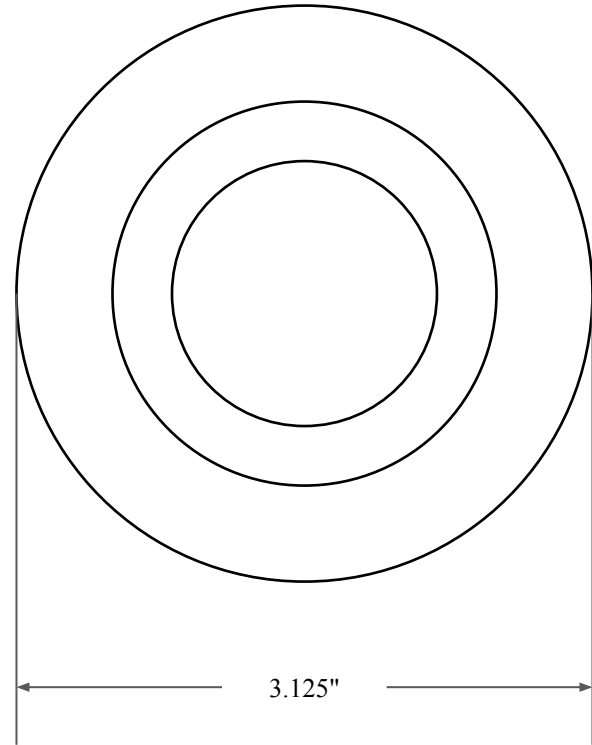

2.187"



3.125"



**GLOBAL O-RING**  
and SEAL  
ALL-AROUND BETTER

14450 John F. Kennedy Blvd.  
Houston, TX 77032

[www.globaloring.com](http://www.globaloring.com)

PART  
NUMBER

**FRS8196ANT**

Fabric Reinforced Oil Seal - Nitrile/PTFE 75 Style A  
Ref: JM Clipper 12364 HIL5 PTFE

Information in this drawing is provided for reference only