

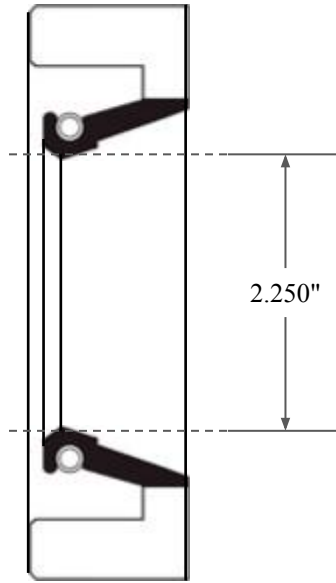

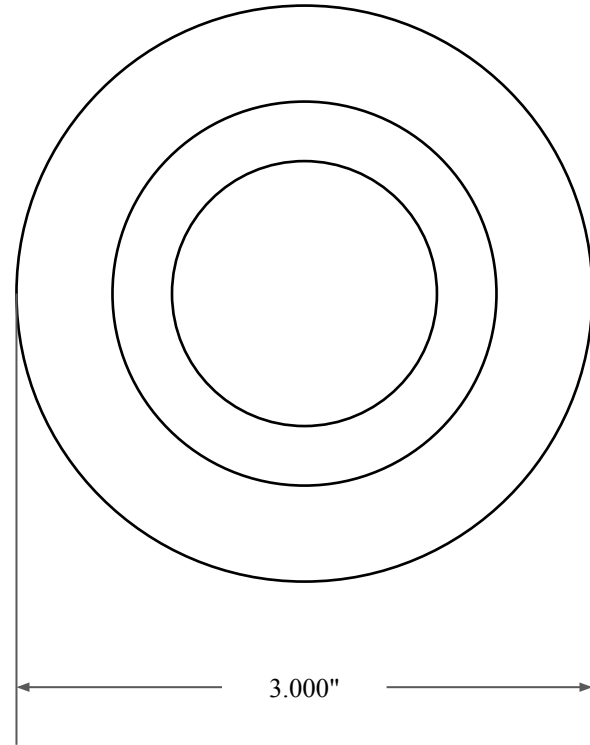

0.438"



2.250"



3.000"

| | |
|---|--|
|  GLOBAL O-RING and SEAL ALL-AROUND BETTER | PART NUMBER FRS8358AV90 |
| 14450 John F. Kennedy Blvd. Houston, TX 77032 www.globaloring.com | Fabric Reinforced Oil Seal - Viton 90 Style A Ref: JM Clipper 14922 HSL16 |
| Information in this drawing is provided for reference only | |