

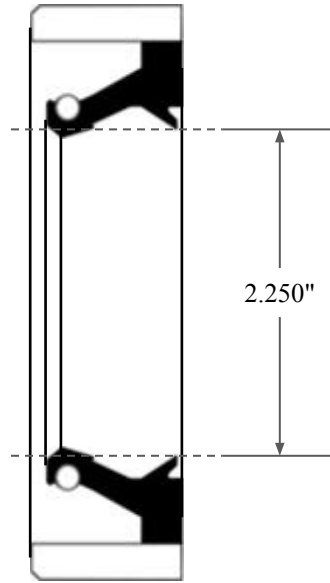

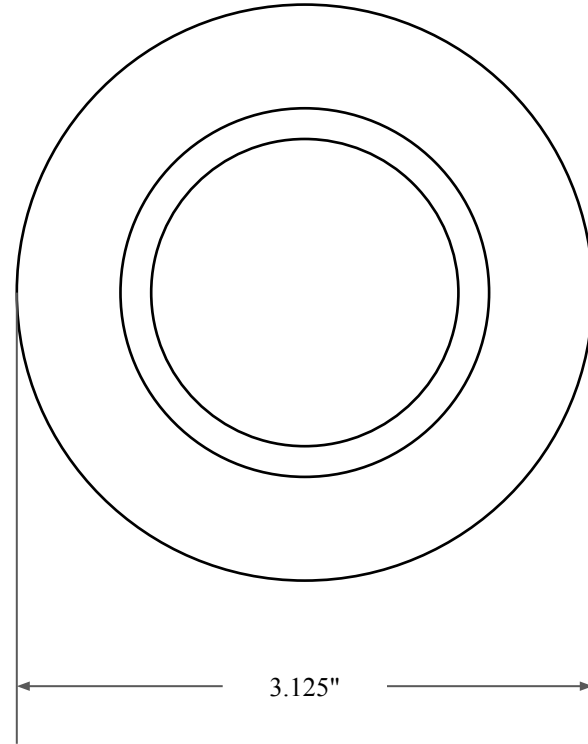

0.438"



2.250"



3.125"

 GLOBAL O-RING and SEAL ALL-AROUND BETTER	PART NUMBER FRS8372C
14450 John F. Kennedy Blvd. Houston, TX 77032	Fabric Reinforced Oil Seal - Nitrile 90 Style C Ref: JM Clipper 19485 H1L5
Information in this drawing is provided for reference only	