

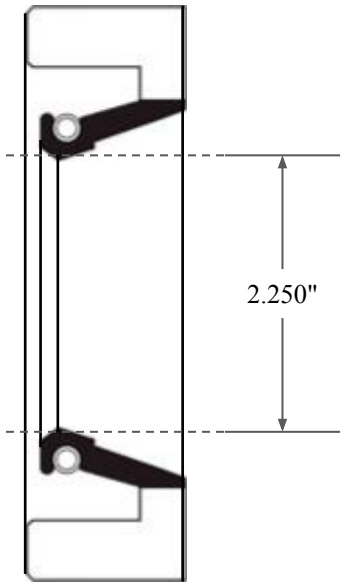

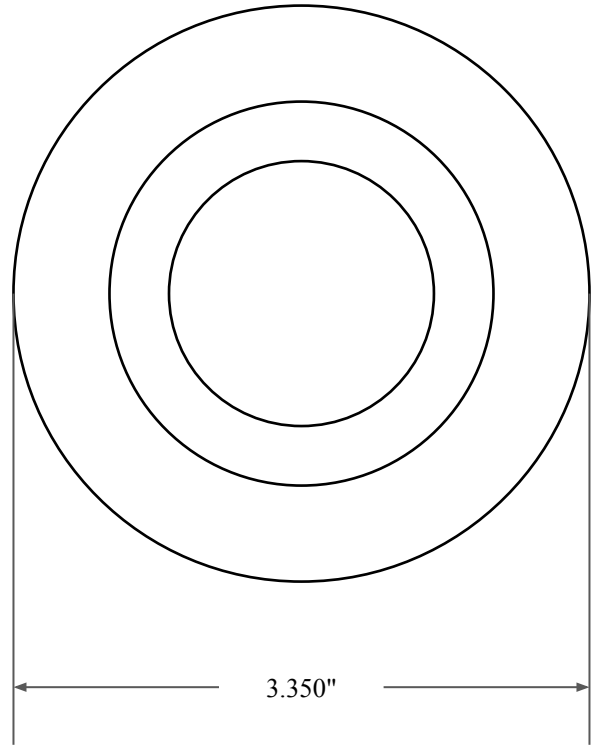

0.500"



2.250"



3.350"

| | |
|---|---|
|  <p>GLOBAL O-RING and SEAL ALL-AROUND BETTER</p> | PART NUMBER FRS8404A |
| 14450 John F. Kennedy Blvd. Houston, TX 77032 | Fabric Reinforced Oil Seal - Nitrile 90 Style A Ref: JM Clipper 10982 H1L5 |
| Information in this drawing is provided for reference only | |