

0.500"

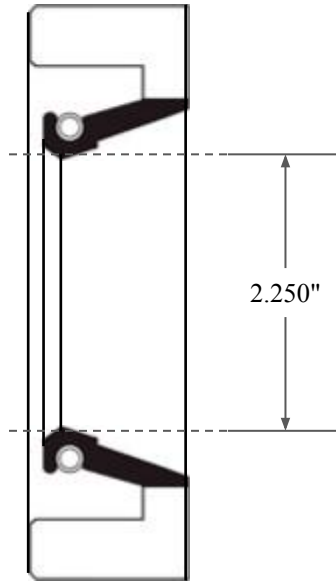

2.250"

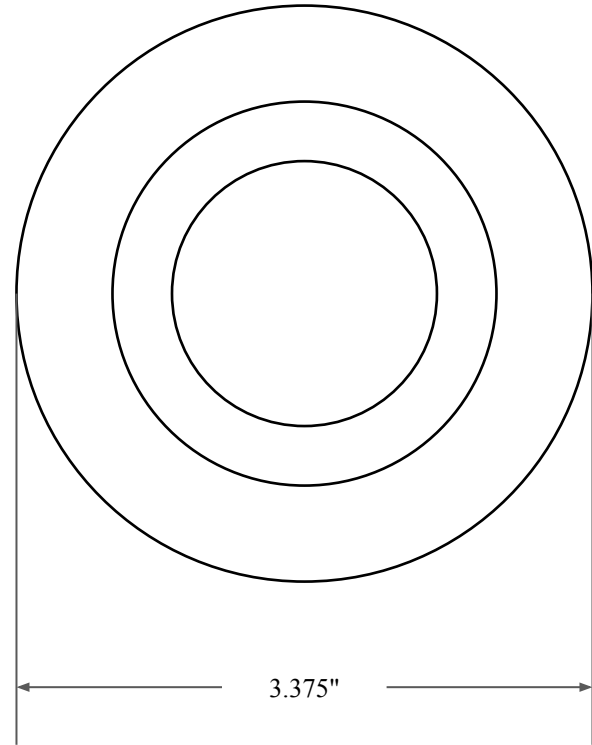

3.375"



14450 John F. Kennedy Blvd.
Houston, TX 77032

www.globaloring.com

PART
NUMBER

FRS8421A

Fabric Reinforced Oil Seal - Nitrile 90 Style A
Ref: JM Clipper 9686 H1L5

Information in this drawing is provided for reference only