

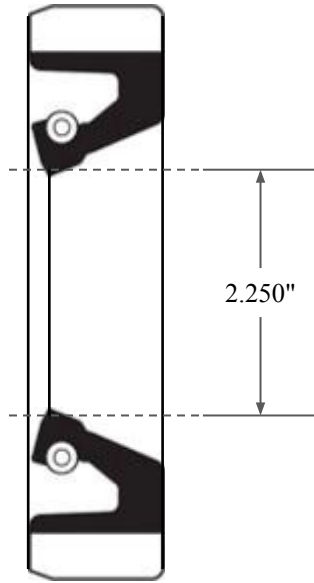

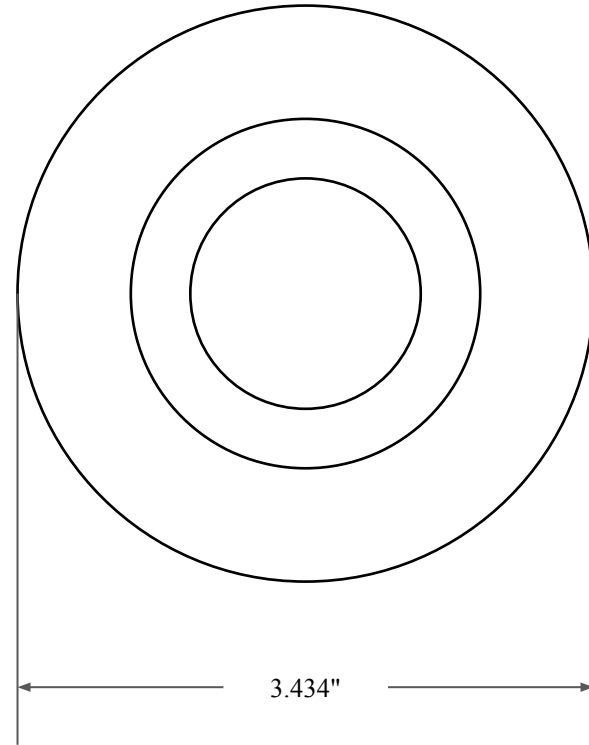

0.500"



2.250"



3.434"

 GLOBAL O-RING and SEAL ALL-AROUND BETTER	PART NUMBER FRS8423B
14450 John F. Kennedy Blvd. Houston, TX 77032	Fabric Reinforced Oil Seal - Nitrile 90 Style B Ref: JM Clipper 6207 H1L5
Information in this drawing is provided for reference only	