

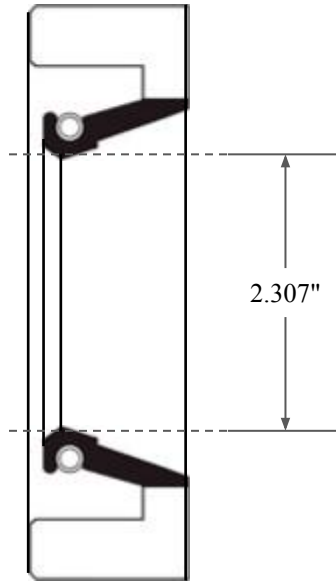

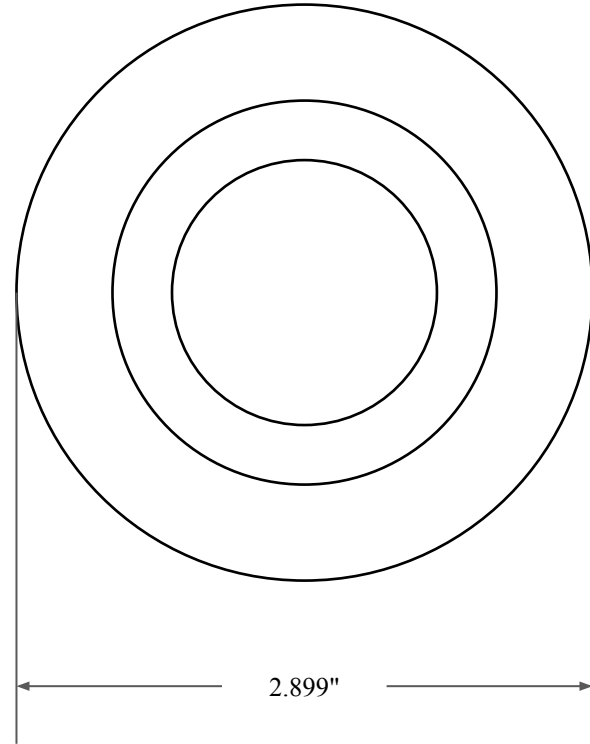

0.337"



2.307"



2.899"

 GLOBAL O-RING and SEAL ALL-AROUND BETTER	PART NUMBER FRS8531A
14450 John F. Kennedy Blvd. Houston, TX 77032	Fabric Reinforced Oil Seal - Nitrile 90 Style A Ref: JM Clipper 10318 H1L5
Information in this drawing is provided for reference only	