

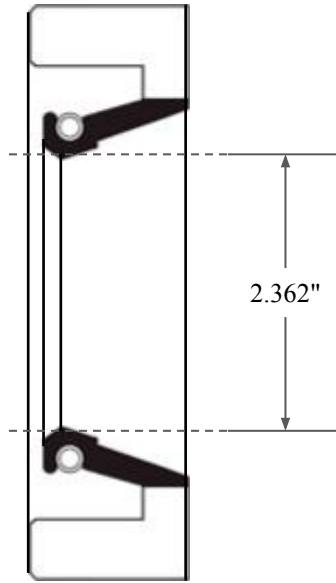

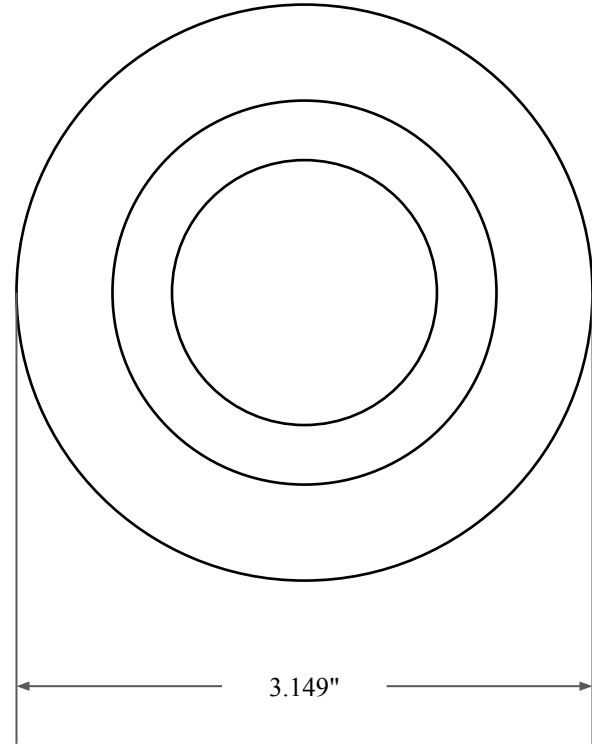

0.393"



2.362"



3.149"

 <p><b>GLOBAL O-RING</b> and SEAL ALL-AROUND BETTER</p>	PART NUMBER <b>FRS8659AV90</b>
14450 John F. Kennedy Blvd. Houston, TX 77032	Fabric Reinforced Oil Seal - Viton 90 Style A Ref: JM Clipper 14643 HSL16
Information in this drawing is provided for reference only	