

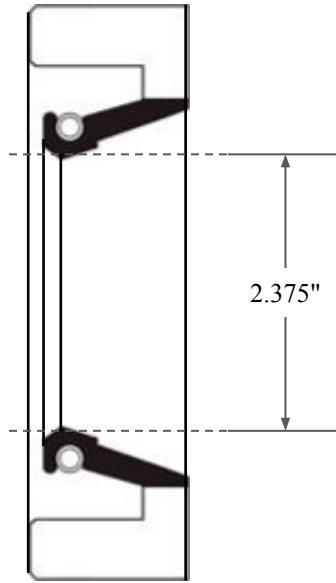

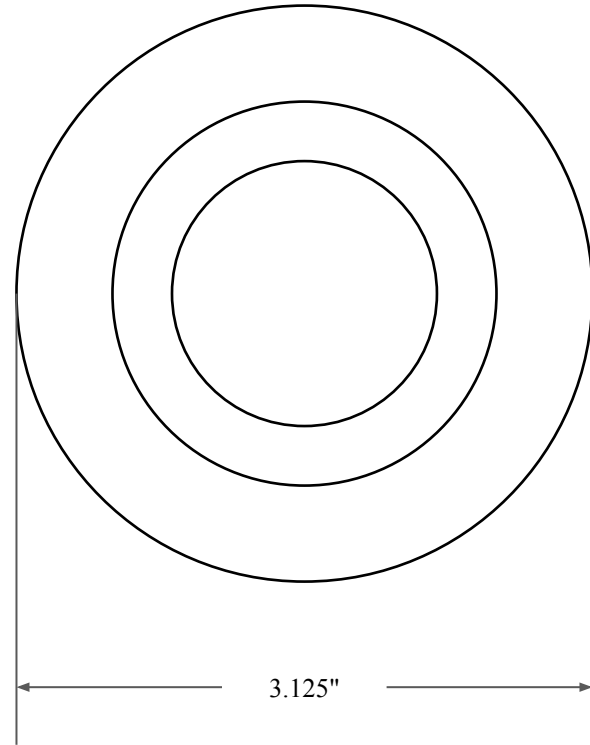

0.375"



2.375"



3.125"

 GLOBAL O-RING and SEAL ALL-AROUND BETTER	PART NUMBER FRS8746AVT90
14450 John F. Kennedy Blvd. Houston, TX 77032 www.globaloring.com	Fabric Reinforced Oil Seal - Viton/PTFE 90 Style A Ref: JM Clipper 9546 H5L16 PTFE
Information in this drawing is provided for reference only	