

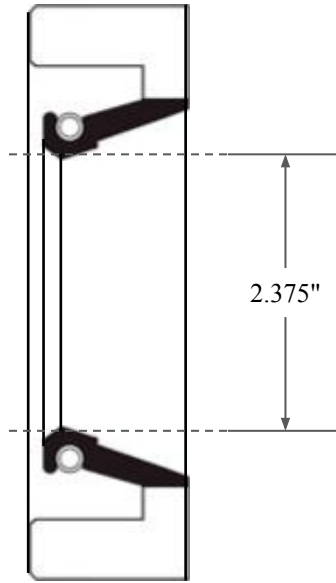

0.500"

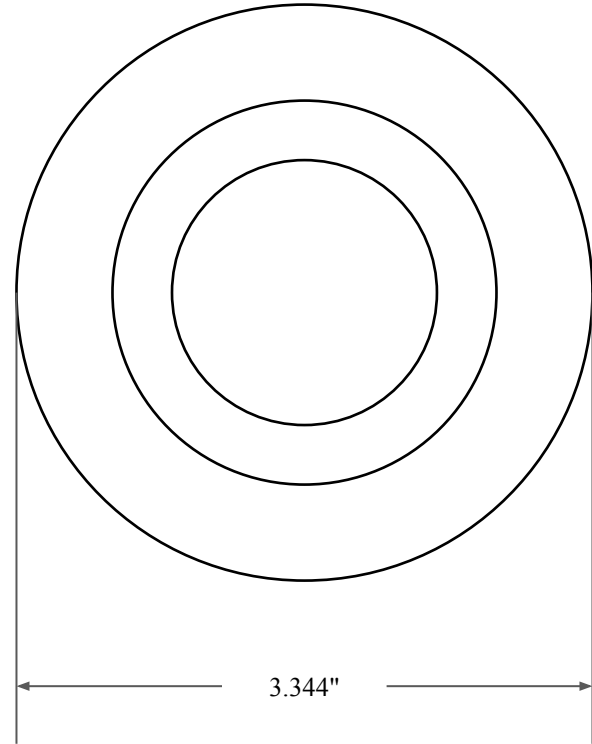

2.375"



3.344"



14450 John F. Kennedy Blvd. www.globaloring.com
Houston, TX 77032

Information in this drawing is provided for reference only

PART NUMBER

FRS8771A

Fabric Reinforced Oil Seal - Nitrile 90 Style A
Ref: JM Clipper 19069 H1L5