

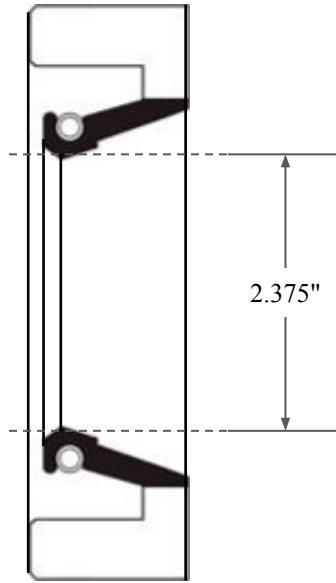

0.500"

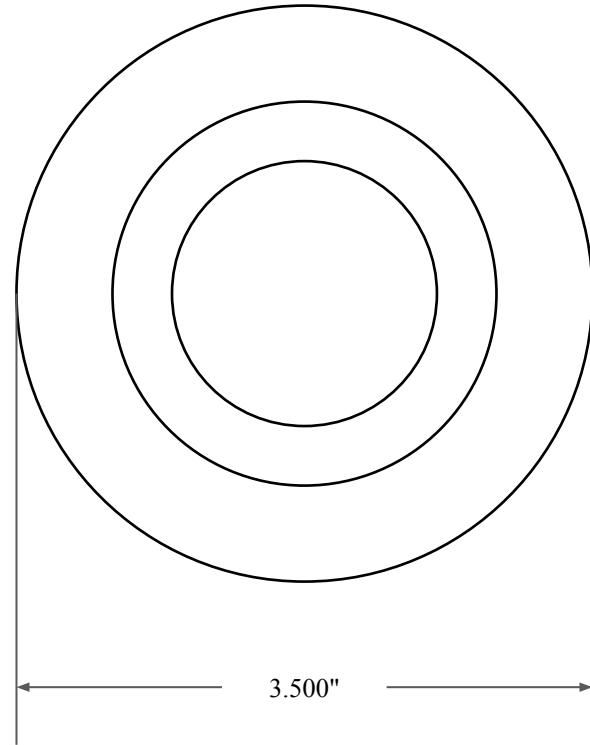

2.375"



3.500"



GLOBAL O-RING
and SEAL
ALL-AROUND BETTER

14450 John F. Kennedy Blvd.
Houston, TX 77032

www.globaloring.com

PART
NUMBER

FRS8801AVT90

Fabric Reinforced Oil Seal - Viton/PTFE 90 Style A
Ref: JM Clipper 9319 H5L16 PTFE

Information in this drawing is provided for reference only