

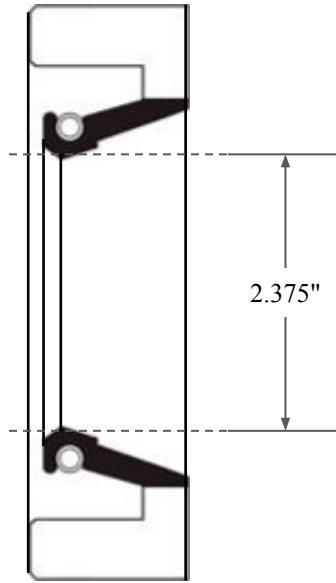

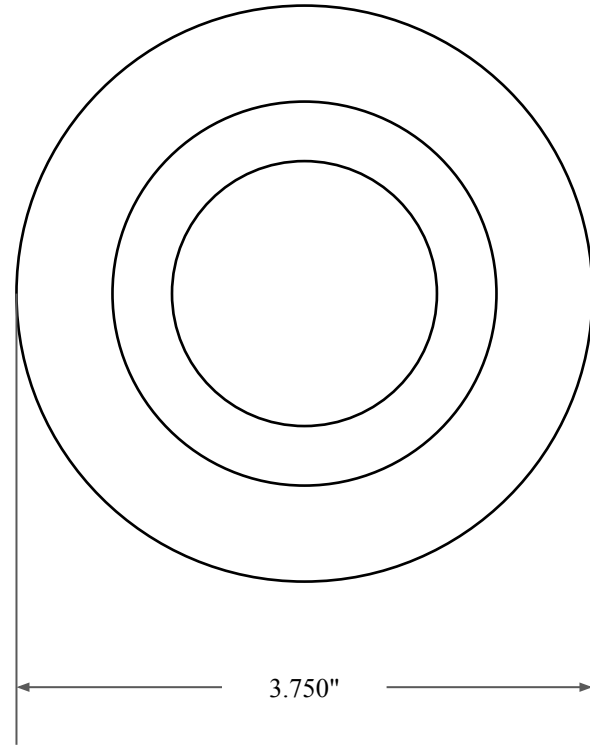

0.469"



2.375"



3.750"

 <p><b>GLOBAL O-RING</b> and SEAL ALL-AROUND BETTER</p>	PART NUMBER <b>FRS8822AV90</b>
14450 John F. Kennedy Blvd. Houston, TX 77032	Fabric Reinforced Oil Seal - Viton 90 Style A Ref: JM Clipper 5931 H5L16
Information in this drawing is provided for reference only	