

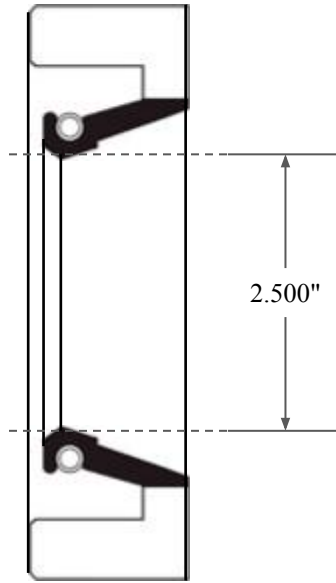

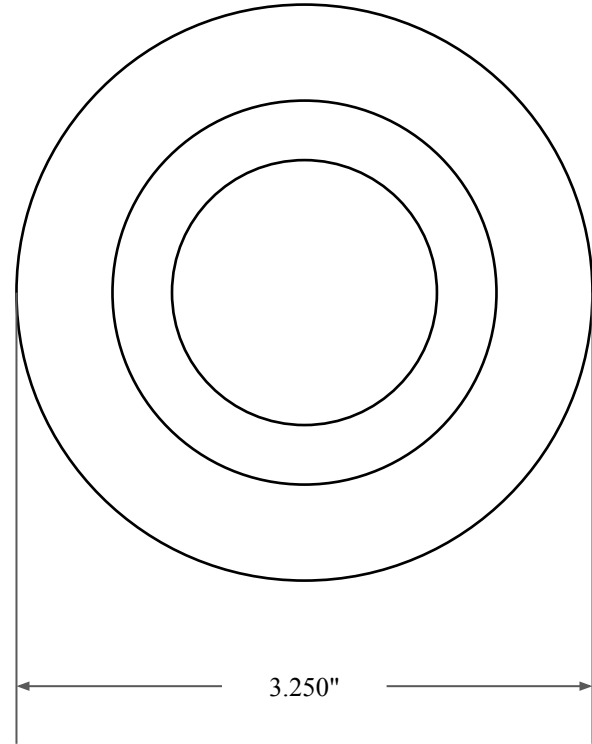

0.500"



2.500"



3.250"

 GLOBAL O-RING and SEAL ALL-AROUND BETTER	PART NUMBER FRS9010AV90
14450 John F. Kennedy Blvd. Houston, TX 77032 www.globaloring.com	Fabric Reinforced Oil Seal - Viton 90 Style A Ref: JM Clipper 9751 H5L89
Information in this drawing is provided for reference only	