

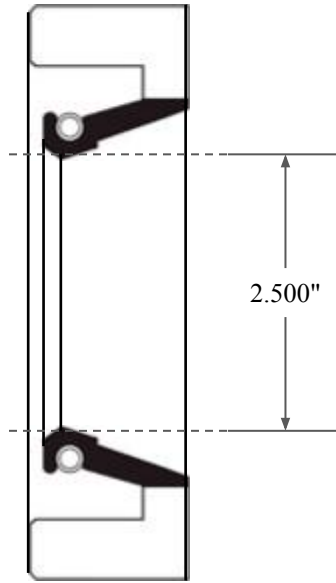

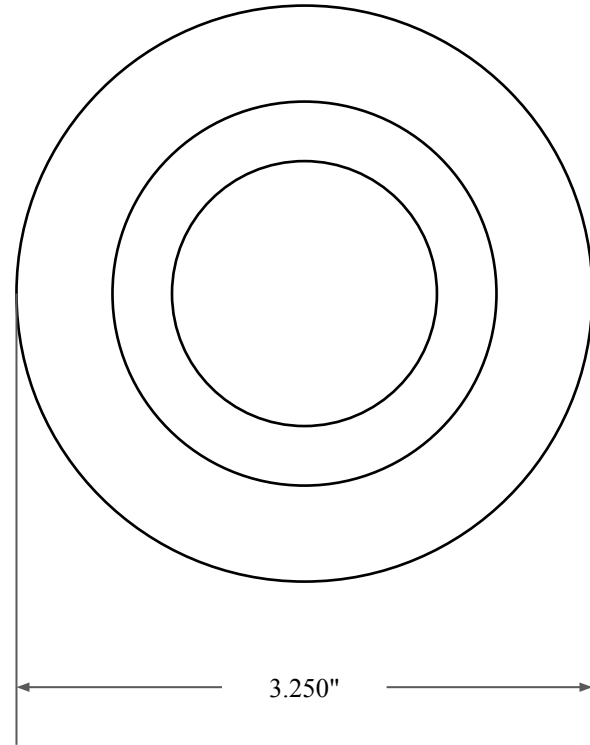

0.500"



2.500"



3.250"

 <p>GLOBAL O-RING and SEAL ALL-AROUND BETTER</p>	PART NUMBER FRS9010AVT90
14450 John F. Kennedy Blvd. Houston, TX 77032	Fabric Reinforced Oil Seal - Viton/PTFE 90 Style A Ref: JM Clipper 9751 H5L89 PTFE
Information in this drawing is provided for reference only	