

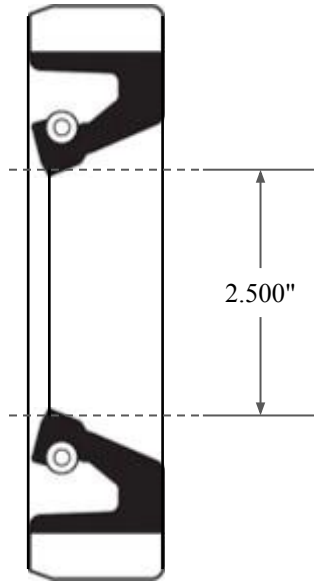

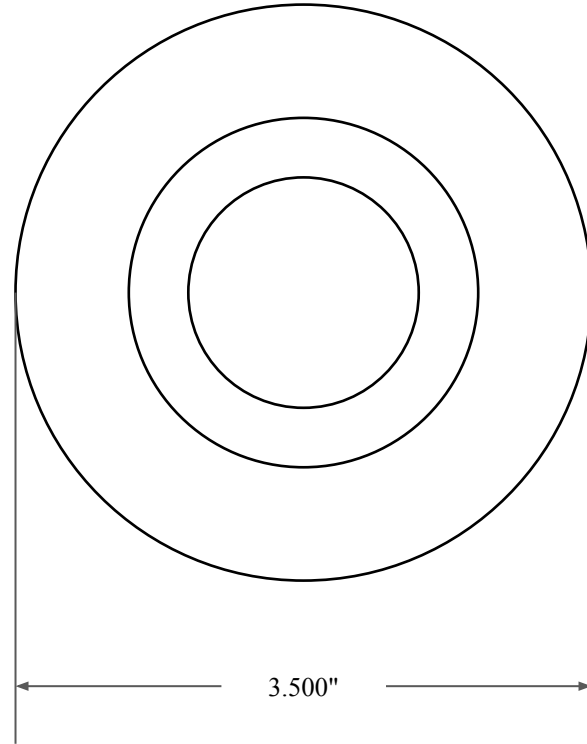

0.438"



2.500"



3.500"

 GLOBAL O-RING and SEAL ALL-AROUND BETTER	PART NUMBER FRS9042BV90
14450 John F. Kennedy Blvd. Houston, TX 77032	Fabric Reinforced Oil Seal - Viton 90 Style B Ref: JM Clipper 9074 H5L16
Information in this drawing is provided for reference only	