

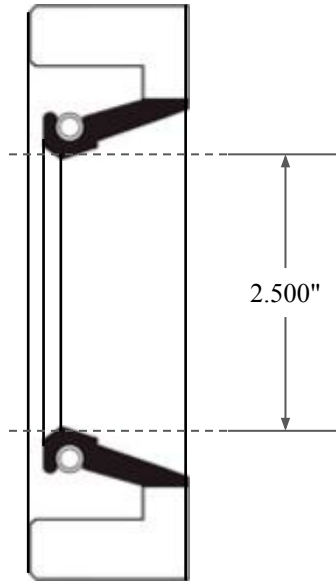

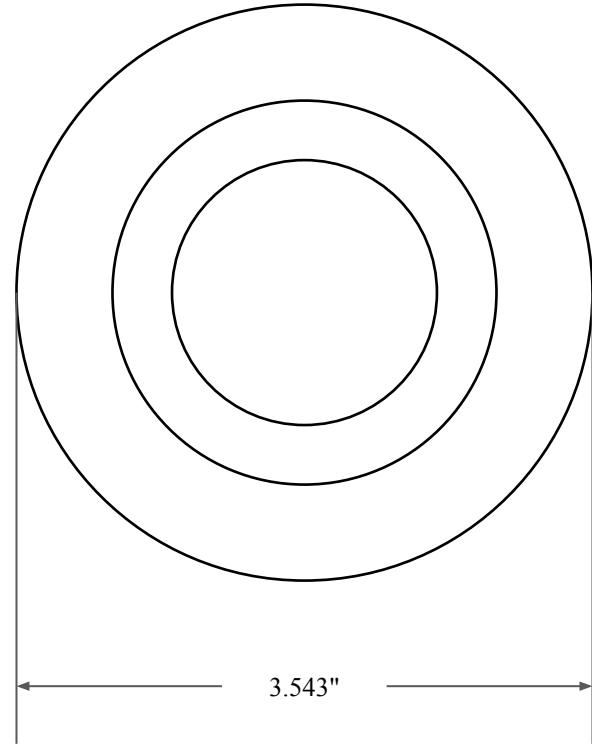

0.500"



2.500"



3.543"

 GLOBAL O-RING and SEAL ALL-AROUND BETTER	PART NUMBER FRS9053AV90
14450 John F. Kennedy Blvd. Houston, TX 77032 www.globaloring.com	Fabric Reinforced Oil Seal - Viton 90 Style A Ref: JM Clipper 10953 HSL16
Information in this drawing is provided for reference only	