

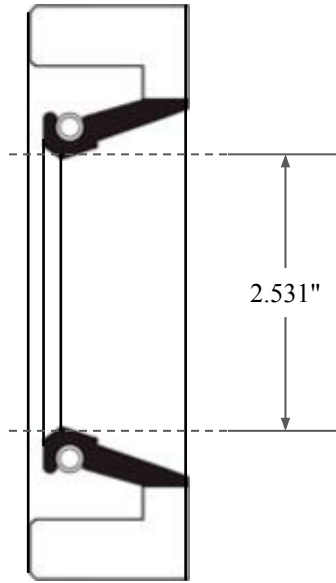

0.438"

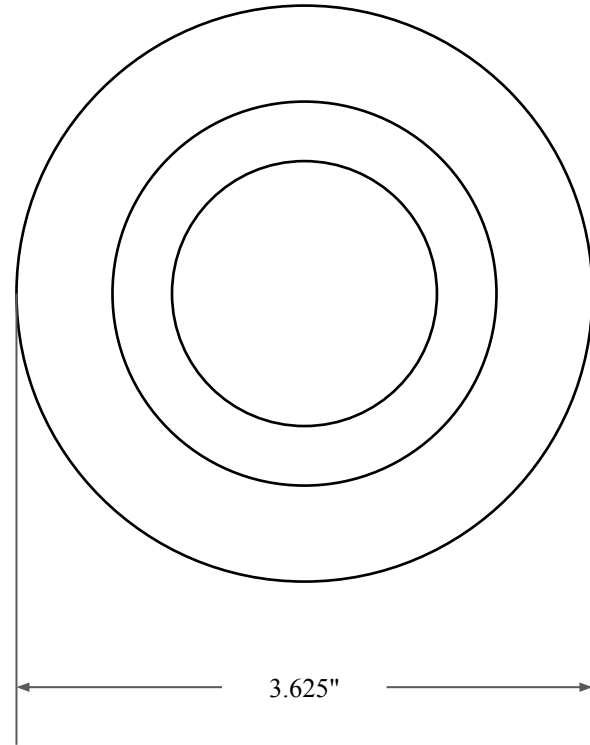

2.531"



3.625"



14450 John F. Kennedy Blvd.
Houston, TX 77032

www.globaloring.com

PART
NUMBER

FRS9133A

Fabric Reinforced Oil Seal - Nitrile 90 Style A
Ref: JM Clipper 7163 HIL5

Information in this drawing is provided for reference only