

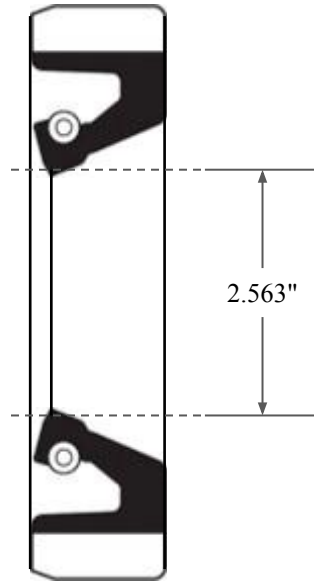

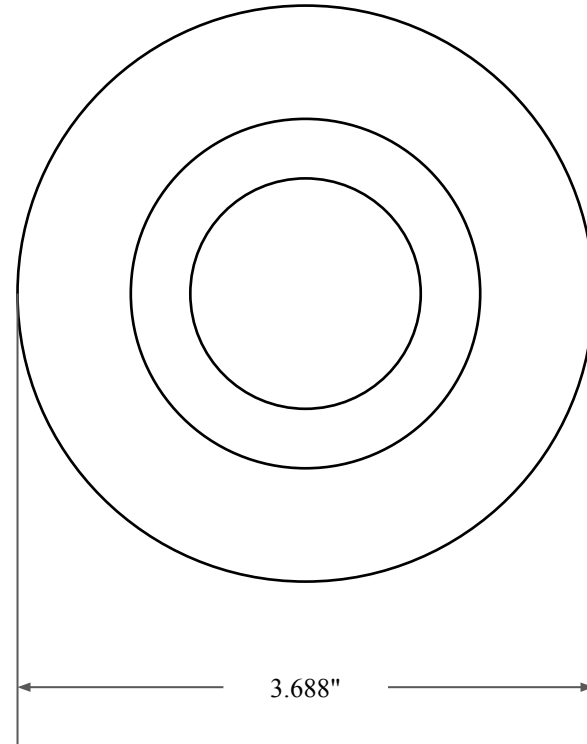

0.438"



2.563"



3.688"

 <b>GLOBAL O-RING</b> and SEAL ALL-AROUND BETTER	PART NUMBER <b>FRS9261B</b>
14450 John F. Kennedy Blvd. Houston, TX 77032 <a href="http://www.globaloring.com">www.globaloring.com</a>	Fabric Reinforced Oil Seal - Nitrile 90 Style B Ref: JM Clipper 16098 H1L5
Information in this drawing is provided for reference only	