

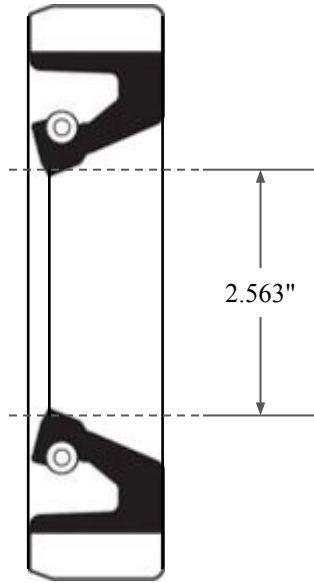

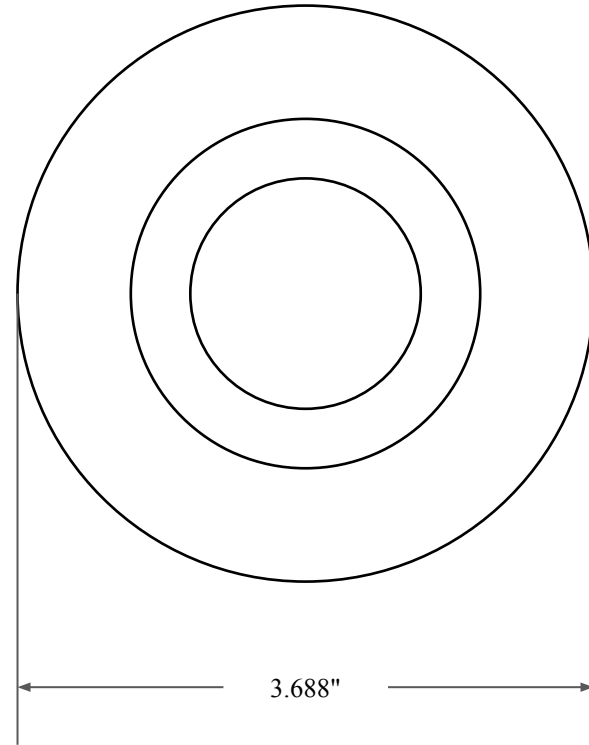

0.469"



2.563"



3.688"

 GLOBAL O-RING and SEAL ALL-AROUND BETTER	PART NUMBER FRS9262B
14450 John F. Kennedy Blvd. Houston, TX 77032	Fabric Reinforced Oil Seal - Nitrile 90 Style B Ref: JM Clipper 0256 9386
Information in this drawing is provided for reference only	