

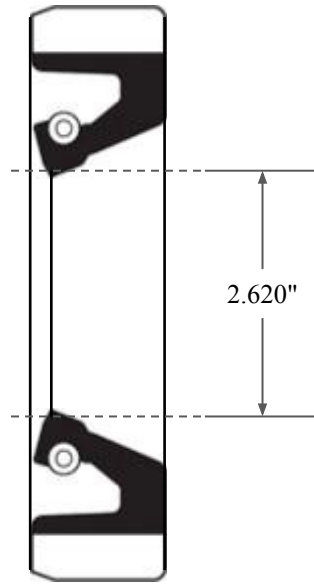

0.313"

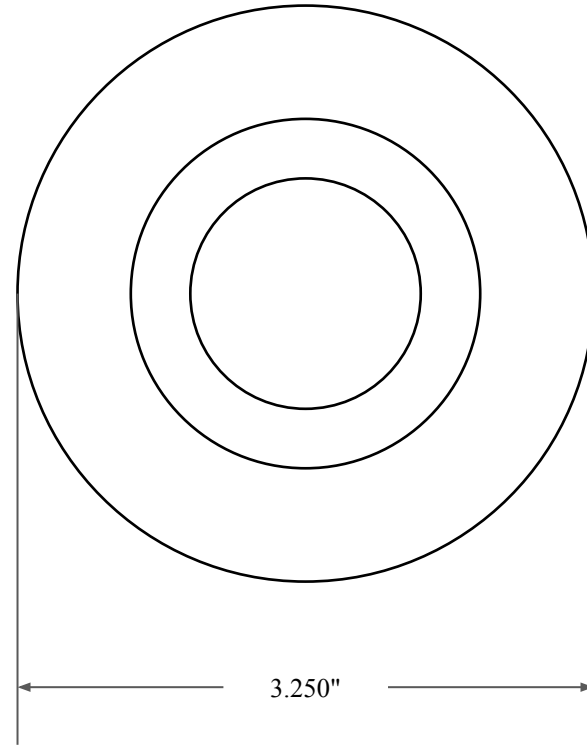

2.620"



3.250"



GLOBAL O-RING
and SEAL
ALL-AROUND BETTER

PART
NUMBER

FRS9290B

14450 John F. Kennedy Blvd.
Houston, TX 77032

www.globaloring.com

Fabric Reinforced Oil Seal - Nitrile 90 Style B
Ref: JM Clipper 17047 H1L5

Information in this drawing is provided for reference only