

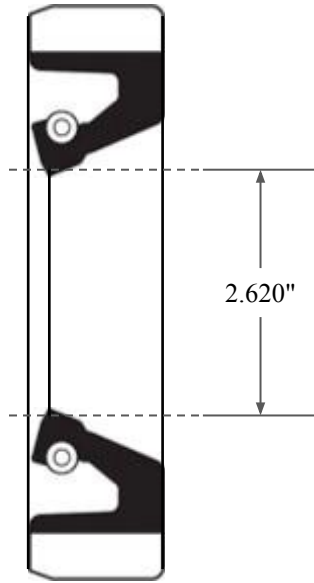

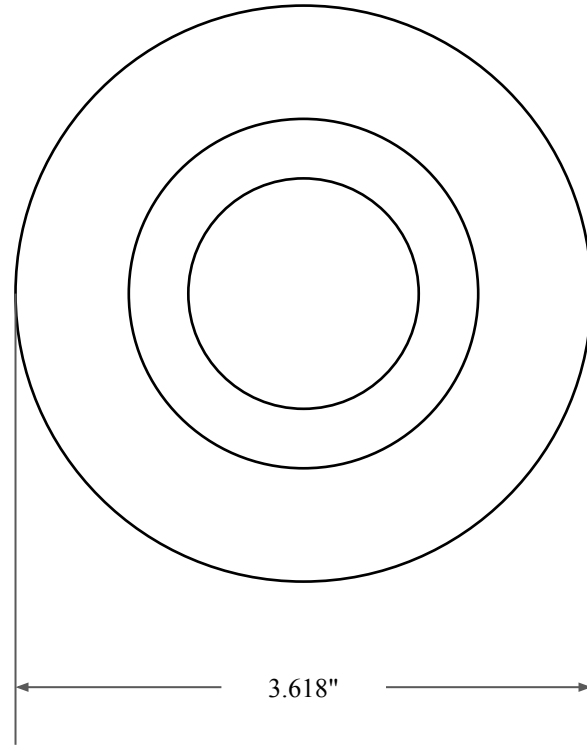

0.437"



2.620"



3.618"

 GLOBAL O-RING and SEAL ALL-AROUND BETTER	PART NUMBER FRS9292B
14450 John F. Kennedy Blvd. Houston, TX 77032	Fabric Reinforced Oil Seal - Nitrile 90 Style B Ref: JM Clipper 4903 H1L5
Information in this drawing is provided for reference only	