

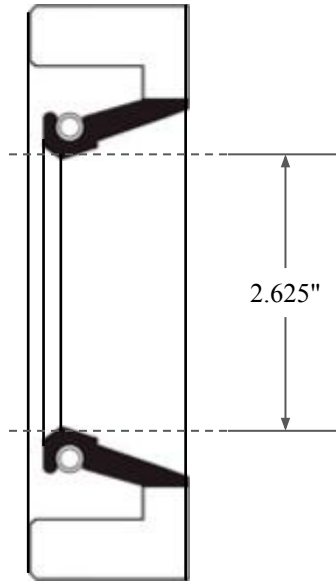

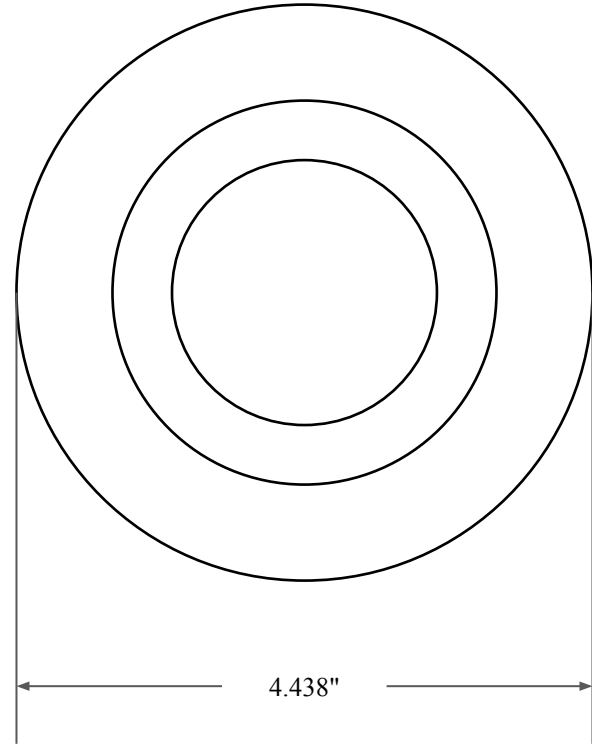

0.500"



2.625"



4.438"

 <p><b>GLOBAL O-RING</b> and SEAL ALL-AROUND BETTER</p>	PART NUMBER <b>FRS9375A</b>
14450 John F. Kennedy Blvd. Houston, TX 77032	Fabric Reinforced Oil Seal - Nitrile 90 Style A Ref: JM Clipper 10028 H1L5
Information in this drawing is provided for reference only	