

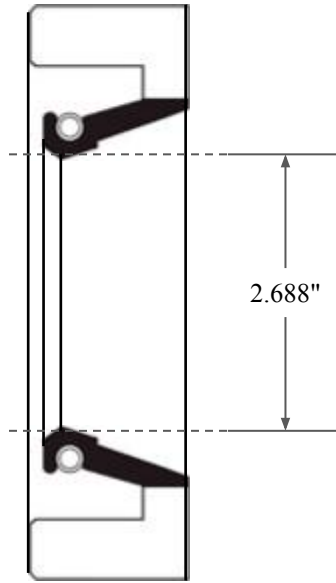

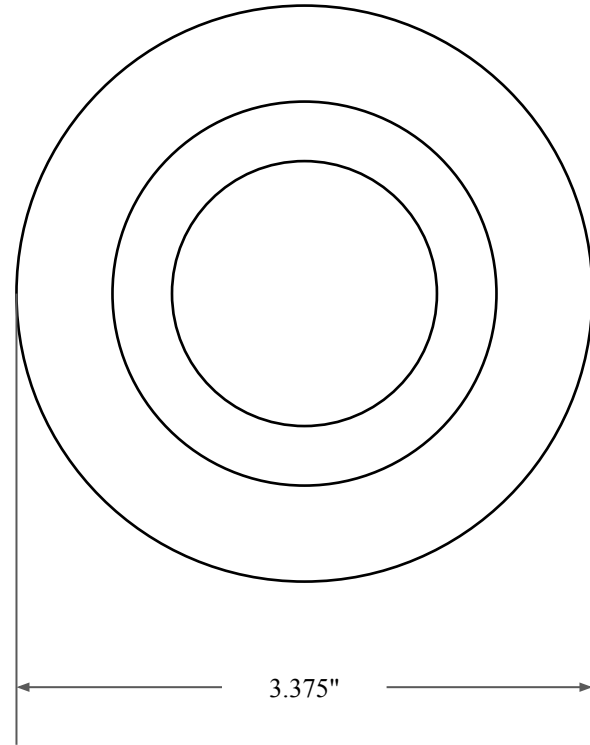

0.375"



2.688"



3.375"

 GLOBAL O-RING and SEAL ALL-AROUND BETTER	PART NUMBER FRS9446A
14450 John F. Kennedy Blvd. Houston, TX 77032 www.globaloring.com	Fabric Reinforced Oil Seal - Nitrile 90 Style A Ref: JM Clipper 11142 H1L5
Information in this drawing is provided for reference only	