

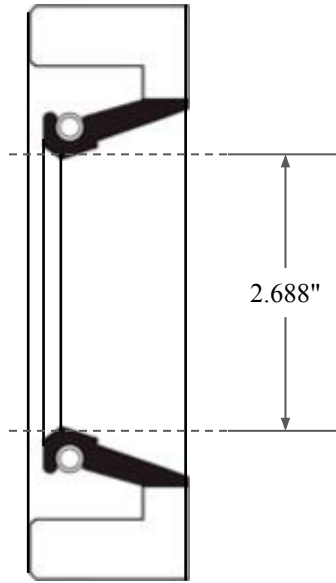

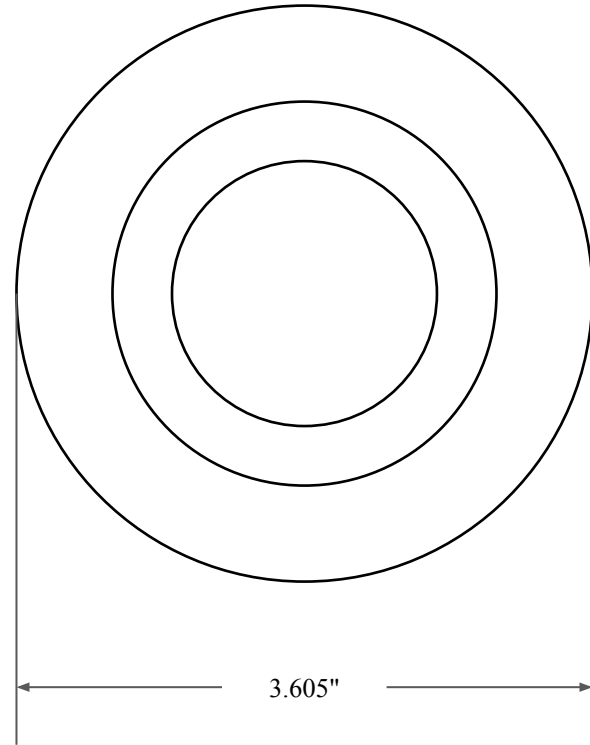

0.438"



2.688"



3.605"

 GLOBAL O-RING and SEAL ALL-AROUND BETTER	PART NUMBER FRS9453A
14450 John F. Kennedy Blvd. Houston, TX 77032	Fabric Reinforced Oil Seal - Nitrile 90 Style A Ref: JM Clipper 11230 H1L5
Information in this drawing is provided for reference only	