

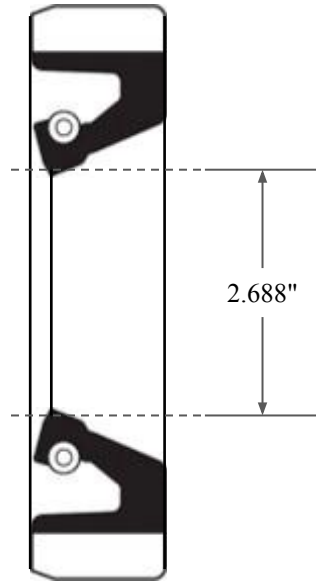

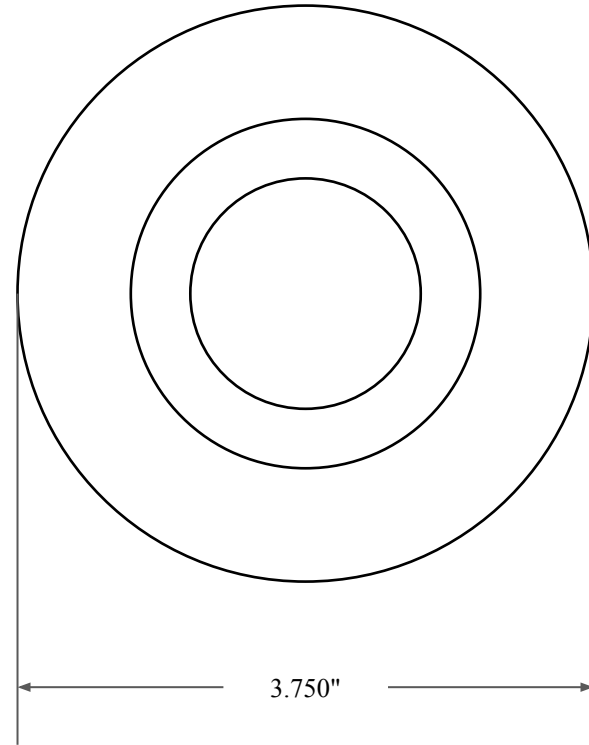

0.438"



2.688"



3.750"

 GLOBAL O-RING and SEAL ALL-AROUND BETTER	PART NUMBER FRS9458B
14450 John F. Kennedy Blvd. Houston, TX 77032	Fabric Reinforced Oil Seal - Nitrile 90 Style B Ref: JM Clipper 0268 10168
Information in this drawing is provided for reference only	