

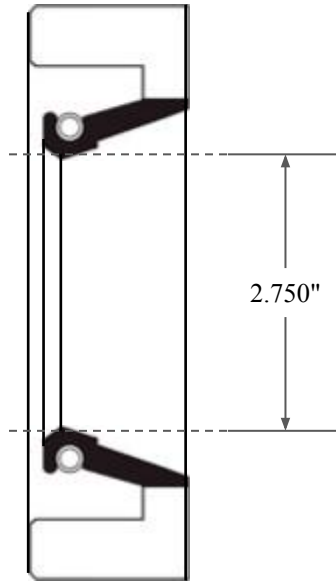

0.375"

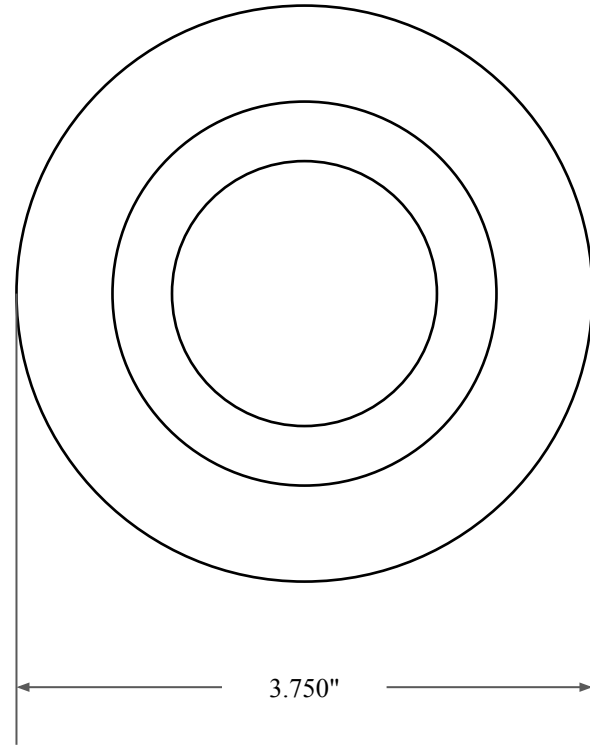

2.750"



3.750"



GLOBAL O-RING
and SEAL
ALL-AROUND BETTER

14450 John F. Kennedy Blvd.
Houston, TX 77032

www.globaloring.com

PART
NUMBER

FRS9521AV90

Fabric Reinforced Oil Seal - Viton 90 Style A
Ref: JM Clipper 7128 H5MX5489

Information in this drawing is provided for reference only