

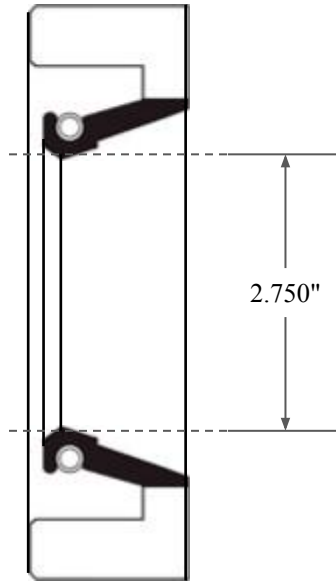

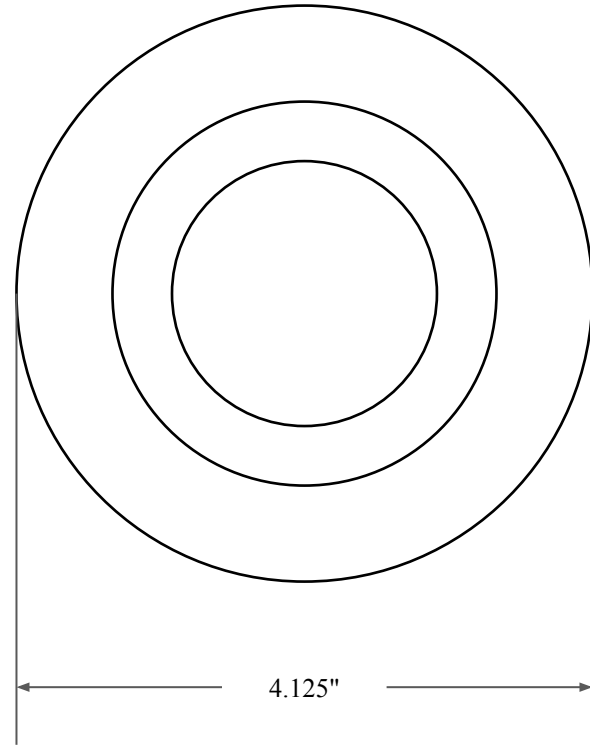

0.438"



2.750"



4.125"

 <p>GLOBAL O-RING and SEAL ALL-AROUND BETTER</p>	PART NUMBER FRS9557ANT
14450 John F. Kennedy Blvd. Houston, TX 77032	Fabric Reinforced Oil Seal - Nitrile/PTFE 75 Style A Ref: JM Clipper 8436 HIL5 PTFE
Information in this drawing is provided for reference only	