

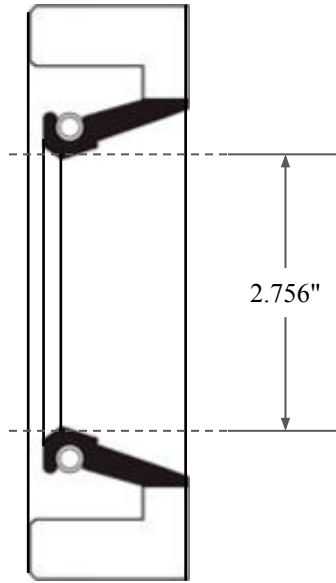

0.394"

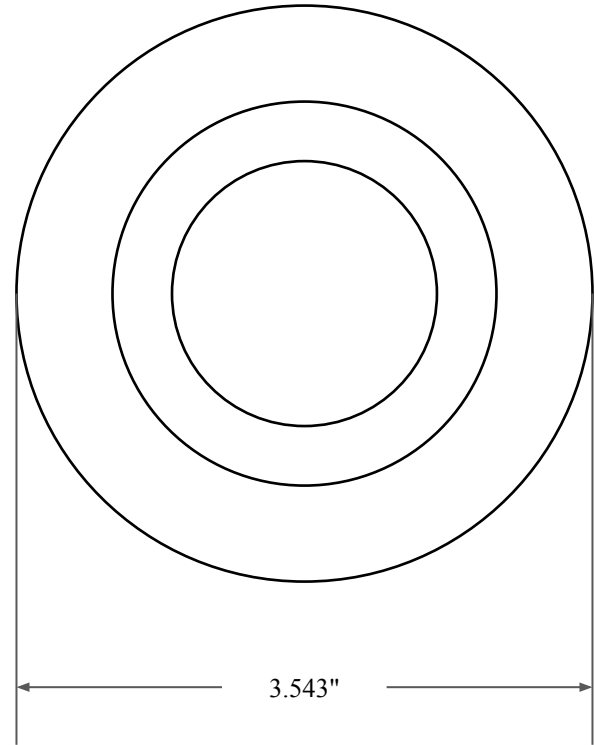

2.756"



3.543"



14450 John F. Kennedy Blvd.
Houston, TX 77032

www.globaloring.com

PART
NUMBER

FRS9604A

Fabric Reinforced Oil Seal - Nitrile 90 Style A
Ref: JM Clipper 15318 H1L5

Information in this drawing is provided for reference only