

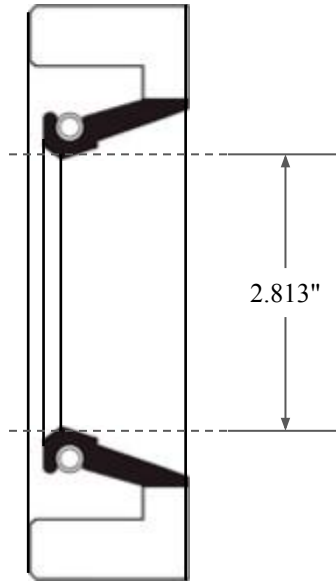

0.313"

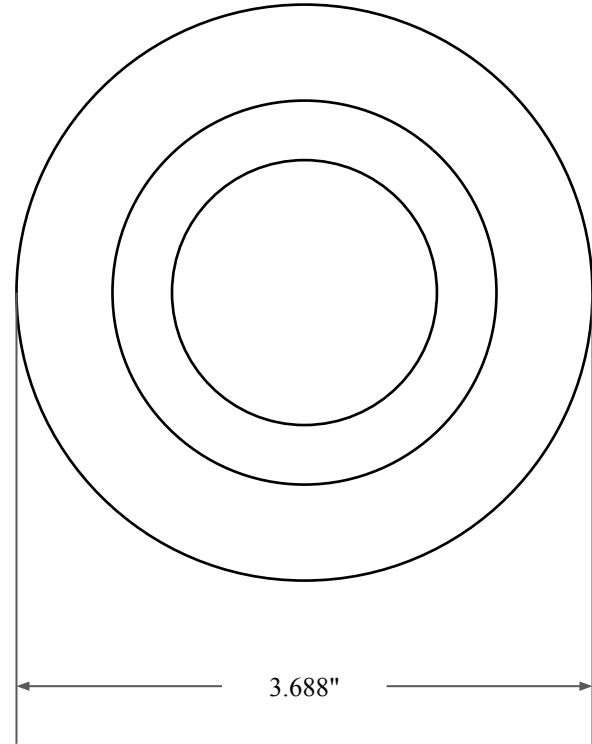

2.813"



3.688"



GLOBAL O-RING
and SEAL
ALL-AROUND BETTER

14450 John F. Kennedy Blvd.
Houston, TX 77032

www.globaloring.com

PART
NUMBER

FRS9680A

Fabric Reinforced Oil Seal - Nitrile 90 Style A
Ref: JM Clipper 9667 H1L5

Information in this drawing is provided for reference only