

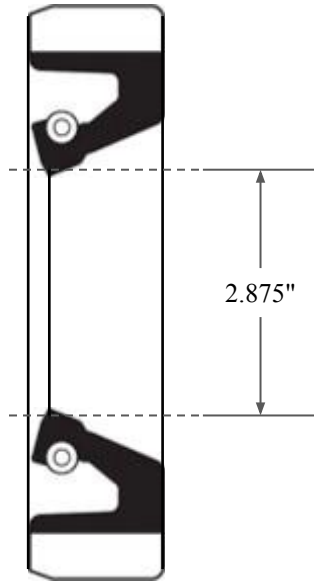

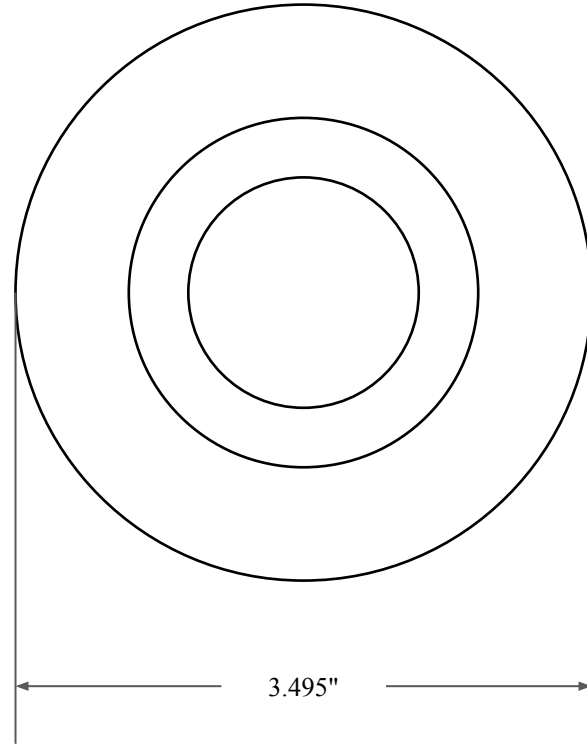

0.375"



2.875"



3.495"

 GLOBAL O-RING and SEAL ALL-AROUND BETTER	PART NUMBER FRS9765B
14450 John F. Kennedy Blvd. Houston, TX 77032	Fabric Reinforced Oil Seal - Nitrile 90 Style B Ref: JM Clipper 0287 14525
Information in this drawing is provided for reference only	