

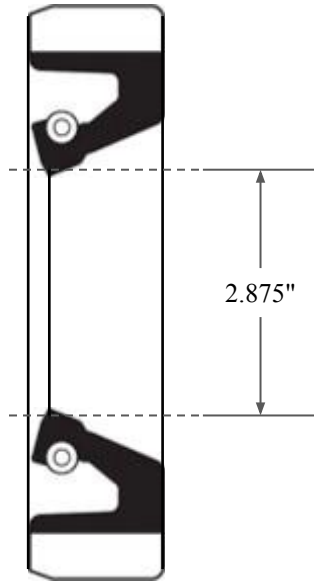

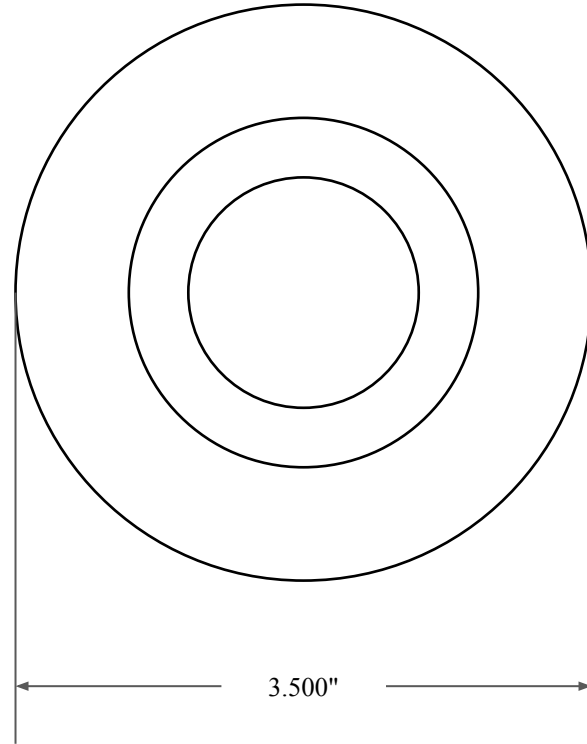

0.313"



2.875"



3.500"

 <b>GLOBAL O-RING</b> and SEAL ALL-AROUND BETTER	PART NUMBER <b>FRS9766BV90</b>
14450 John F. Kennedy Blvd. Houston, TX 77032	Fabric Reinforced Oil Seal - Viton 90 Style B Ref: JM Clipper 18235 HSL16
Information in this drawing is provided for reference only	