

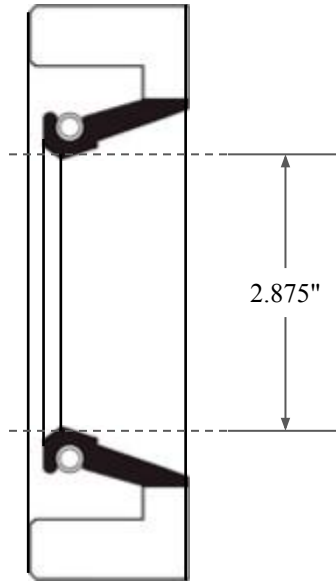

0.375"

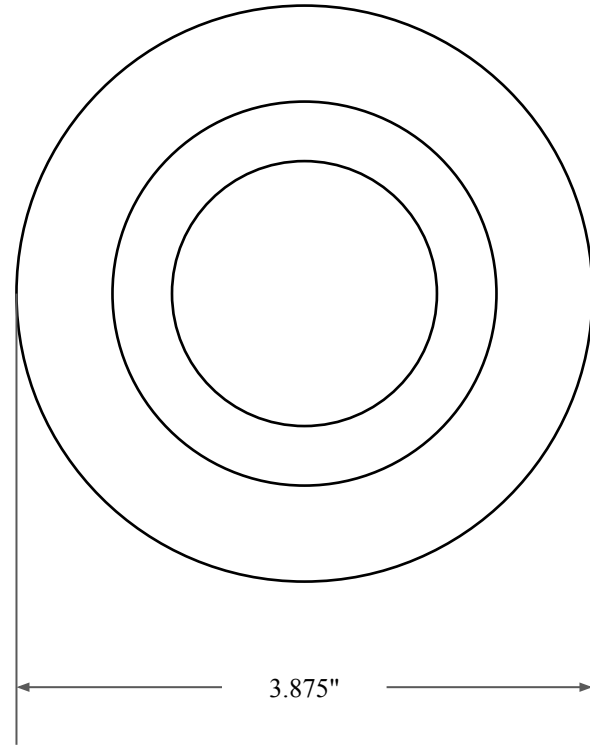

2.875"



3.875"



**GLOBAL O-RING**  
and SEAL  
ALL-AROUND BETTER

14450 John F. Kennedy Blvd.  
Houston, TX 77032

[www.globaloring.com](http://www.globaloring.com)

PART  
NUMBER

**FRS9788AV90**

Fabric Reinforced Oil Seal - Viton 90 Style A  
Ref: JM Clipper 11780 HSL16

Information in this drawing is provided for reference only