

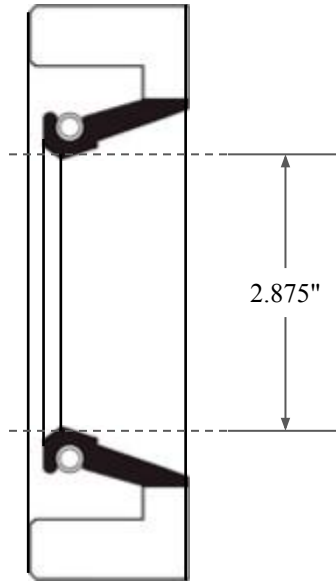

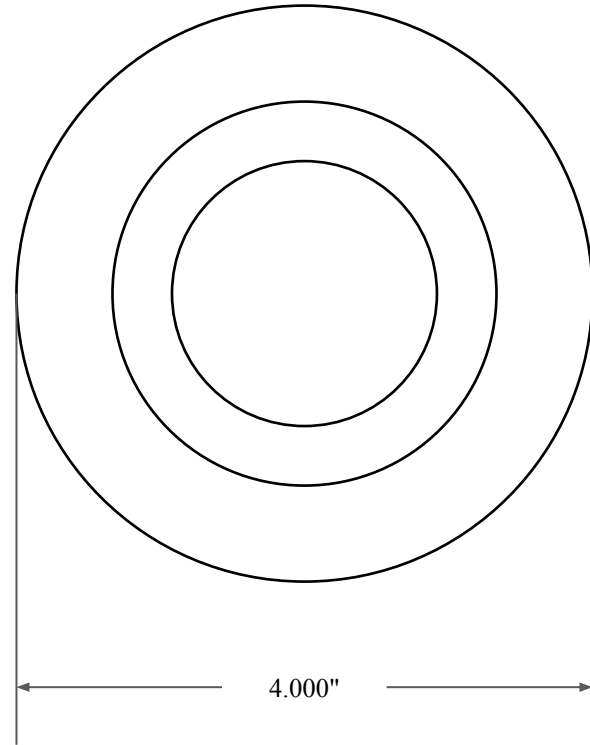

0.469"



2.875"



4.000"

 <p>GLOBAL O-RING and SEAL ALL-AROUND BETTER</p>	PART NUMBER FRS9798AV90
14450 John F. Kennedy Blvd. Houston, TX 77032	Fabric Reinforced Oil Seal - Viton 90 Style A Ref: JM Clipper 9488 H5L16
Information in this drawing is provided for reference only	