

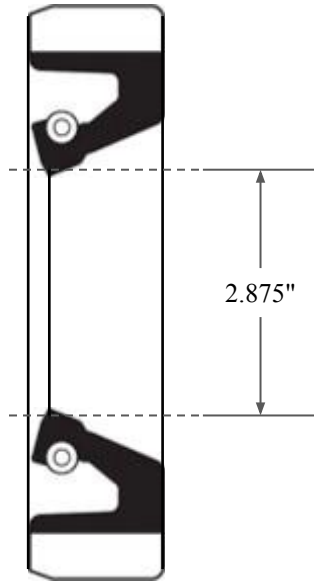

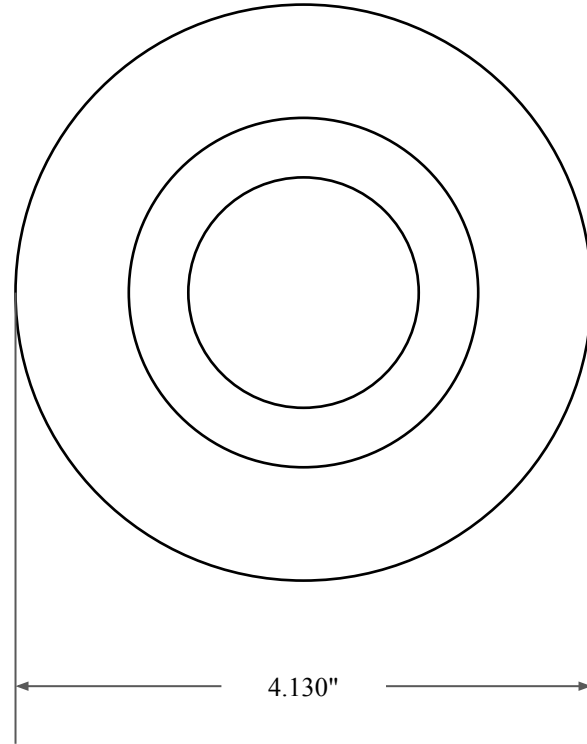

0.563"



2.875"



4.130"

 GLOBAL O-RING and SEAL ALL-AROUND BETTER	PART NUMBER FRS9808B
14450 John F. Kennedy Blvd. Houston, TX 77032	Fabric Reinforced Oil Seal - Nitrile 90 Style B Ref: JM Clipper 0287 3939
Information in this drawing is provided for reference only	