

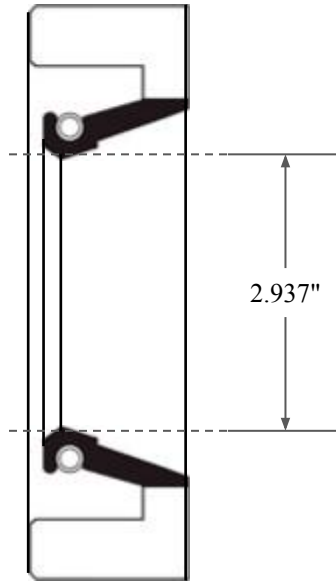

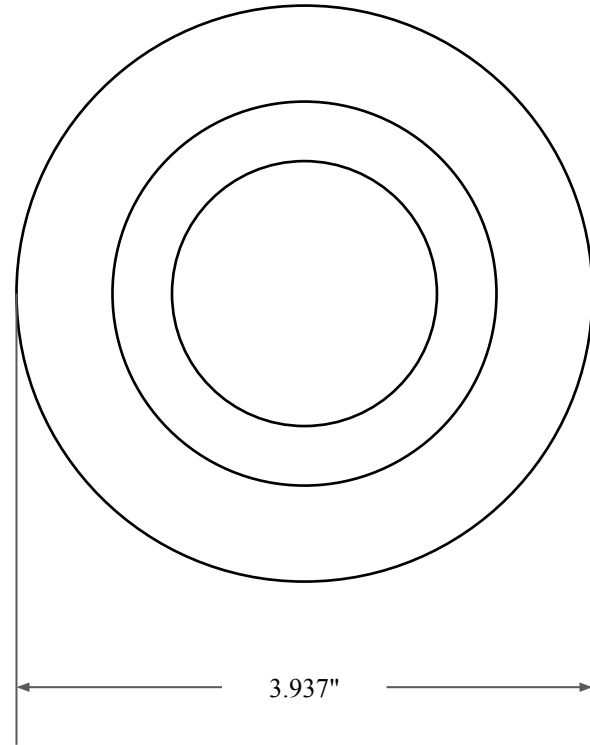

0.500"



2.937"



3.937"

 GLOBAL O-RING and SEAL ALL-AROUND BETTER	PART NUMBER FRS9853A
14450 John F. Kennedy Blvd. Houston, TX 77032	Fabric Reinforced Oil Seal - Nitrile 90 Style A Ref: JM Clipper 4183 H1L5
Information in this drawing is provided for reference only	