

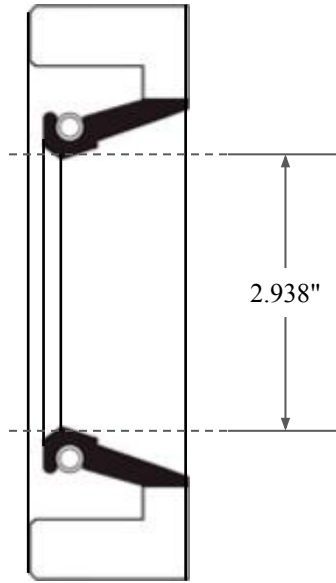

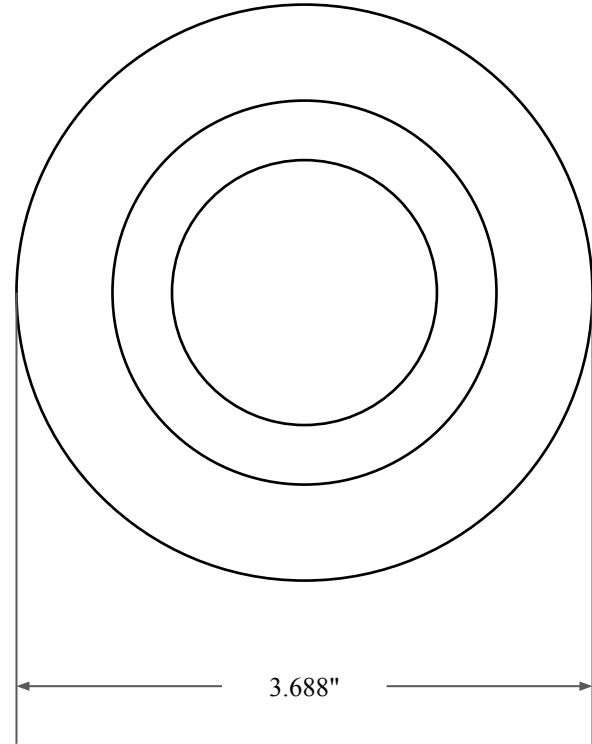

0.313"



2.938"



3.688"

 <p>GLOBAL O-RING and SEAL ALL-AROUND BETTER</p>	PART NUMBER FRS9867A
14450 John F. Kennedy Blvd. Houston, TX 77032	Fabric Reinforced Oil Seal - Nitrile 90 Style A Ref: JM Clipper 15779 H1L5
Information in this drawing is provided for reference only	