

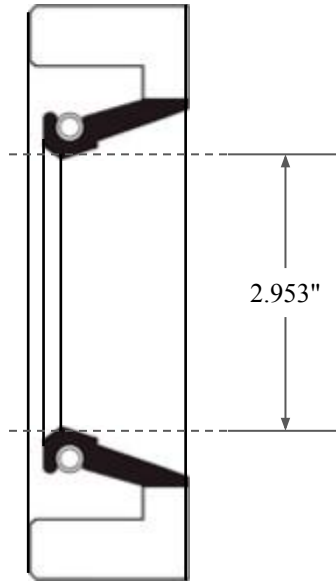

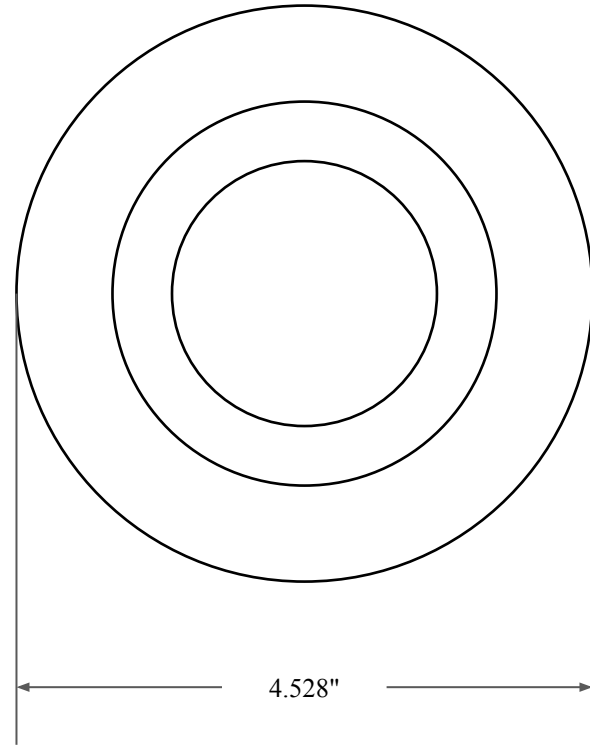

0.375"



2.953"



4.528"

 GLOBAL O-RING and SEAL ALL-AROUND BETTER	PART NUMBER FRS9968ANT
14450 John F. Kennedy Blvd. Houston, TX 77032 www.globaloring.com	Fabric Reinforced Oil Seal - Nitrile/PTFE 75 Style A Ref: JM Clipper 11292 HIL5 PTFE
Information in this drawing is provided for reference only	