

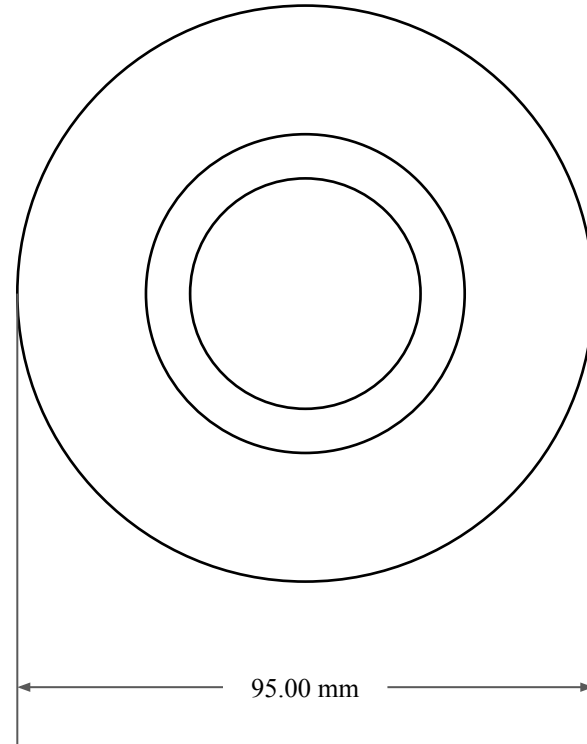



10.00  
mm



80.00 mm



95.00 mm

 <b>GLOBAL O-RING</b> and SEAL ALL-AROUND BETTER	PART NUMBER <b>MOS10247TC</b>
14450 John F. Kennedy Blvd. Houston, TX 77032	www.globaloring.com
Information in this drawing is provided for reference only	

Metric Oil Seal - Nitrile Style TC  
DUAL LIP W/ SPR, RBR OD