

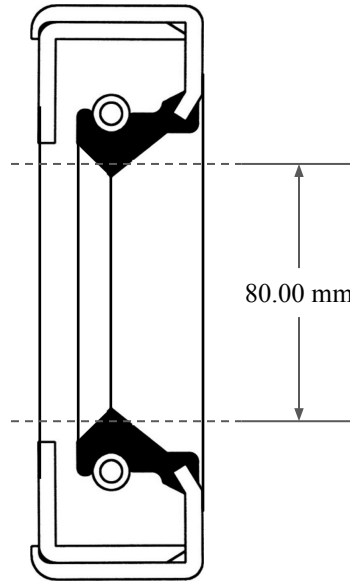

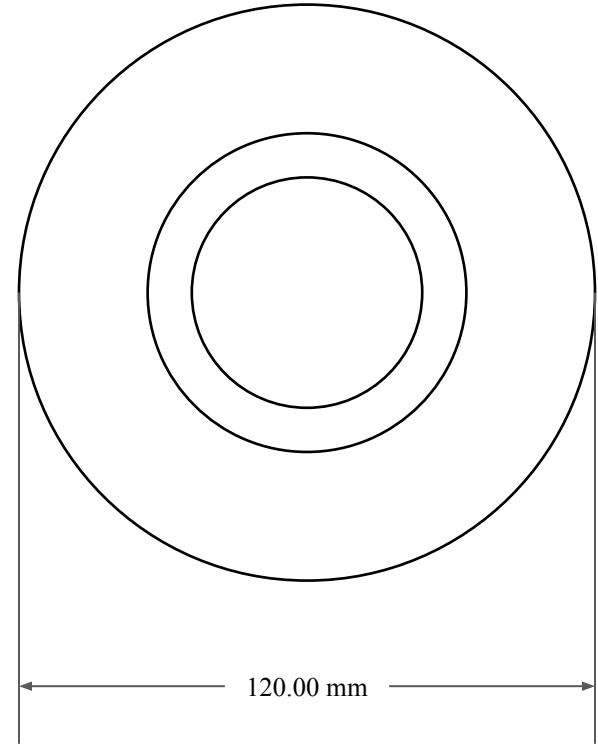

13.00
mm



80.00 mm



120.00 mm

| | |
|---|---|
|  GLOBAL O-RING and SEAL ALL-AROUND BETTER | PART NUMBER MOS10289SA2 |
| 14450 John F. Kennedy Blvd. Houston, TX 77032 www.globaloring.com | Metric Oil Seal - Nitrile Style SA2 SGL LIP W/ SPR, MTL OD W/ RFG PLATE |
| Information in this drawing is provided for reference only | |