

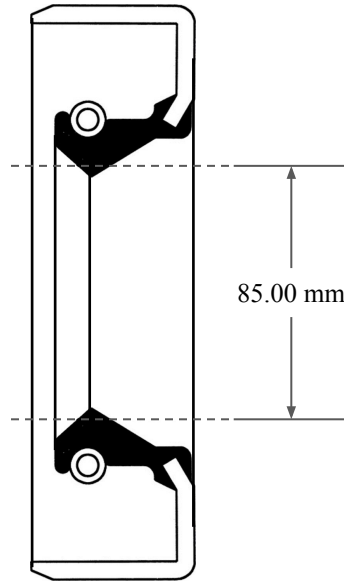

12.00  
mm

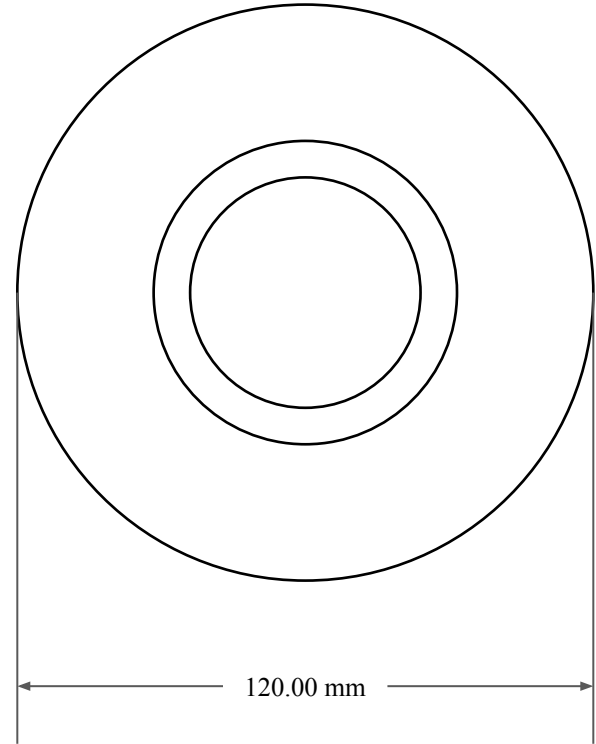

85.00 mm



120.00 mm



14450 John F. Kennedy Blvd.  
Houston, TX 77032

[www.globaloring.com](http://www.globaloring.com)

PART  
NUMBER

**MOS10561SB2**

Metric Oil Seal - Nitrile Style SB2  
SGL LIP W/ SPR, MTL OD

Information in this drawing is provided for reference only