

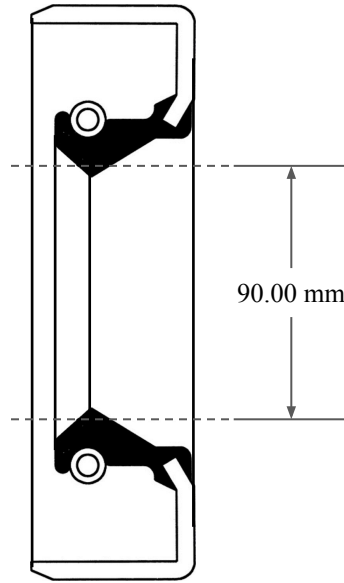

13.00
mm

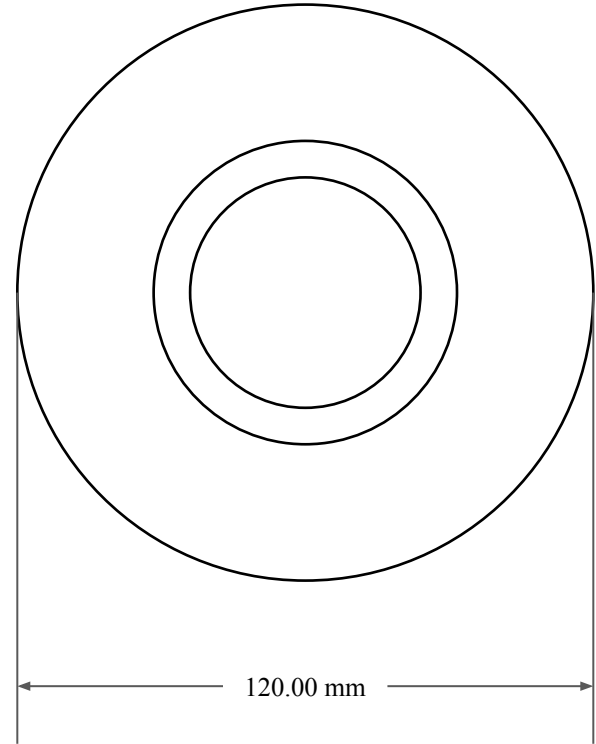

90.00 mm



120.00 mm



GLOBAL O-RING
and SEAL
ALL-AROUND BETTER

14450 John F. Kennedy Blvd.
Houston, TX 77032

www.globaloring.com

Information in this drawing is provided for reference only

PART
NUMBER

MOS10876SB2

Metric Oil Seal - Nitrile Style SB2
SGL LIP W/ SPR, MTL OD