

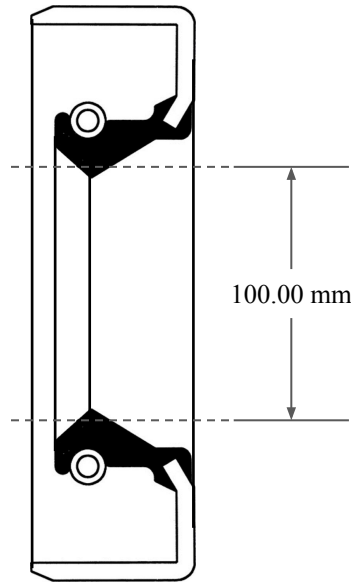

8.00 mm

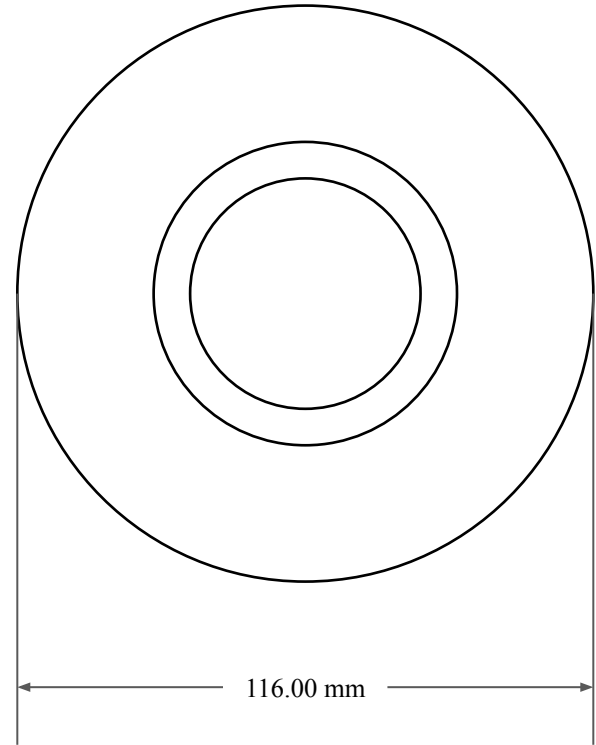

100.00 mm



116.00 mm



14450 John F. Kennedy Blvd.
Houston, TX 77032

www.globaloring.com

PART
NUMBER

MOS11284SB2

Metric Oil Seal - Nitrile Style SB2
SGL LIP W/ SPR, MTL OD

Information in this drawing is provided for reference only