

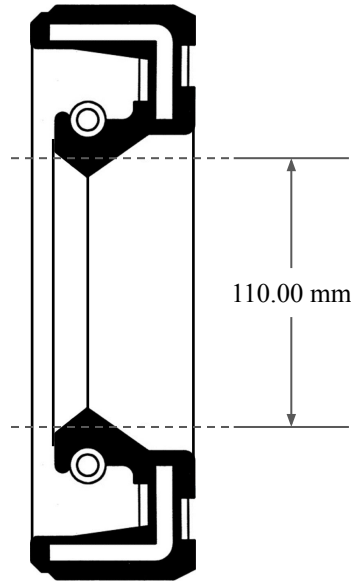

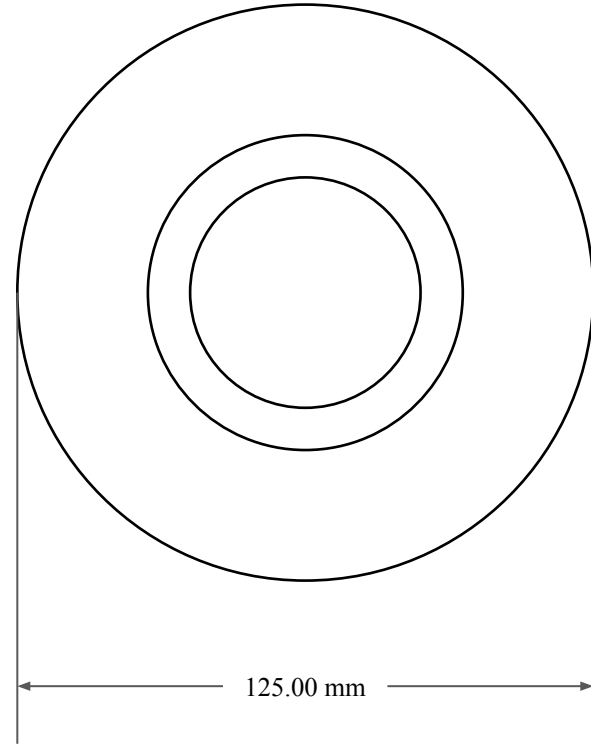

12.00
mm



110.00 mm



125.00 mm

 GLOBAL O-RING and SEAL ALL-AROUND BETTER	PART NUMBER MOS11747SC
14450 John F. Kennedy Blvd. Houston, TX 77032	www.globaloring.com
Information in this drawing is provided for reference only	

Metric Oil Seal - Nitrile Style SC
SGL LIP W/ SPR, RBR OD