

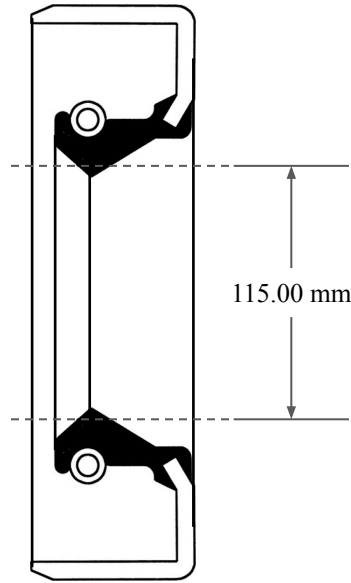

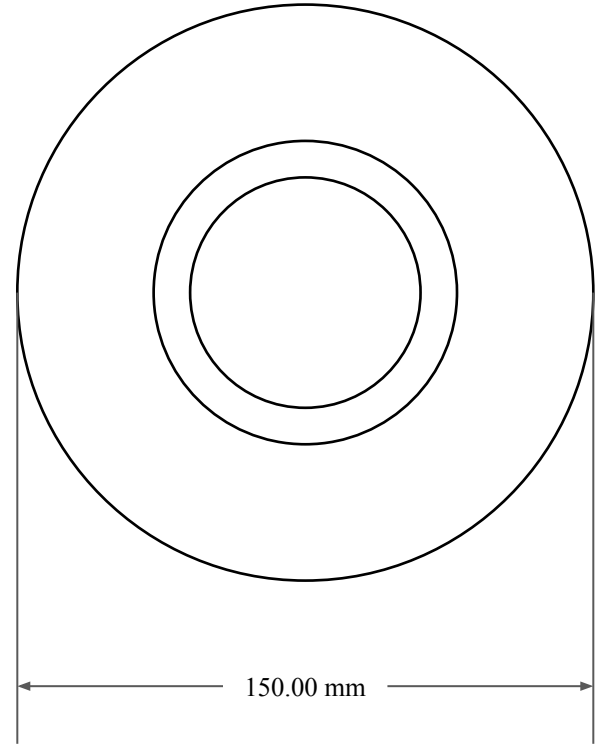

15.00
mm



115.00 mm



150.00 mm

| | |
|---|-----------------------------------|
|  GLOBAL O-RING and SEAL ALL-AROUND BETTER | PART NUMBER MOS11993SB2 |
| 14450 John F. Kennedy Blvd. Houston, TX 77032 | www.globaloring.com |
| Information in this drawing is provided for reference only | |

Metric Oil Seal - Nitrile Style SB2
SGL LIP W/ SPR, MTL OD