

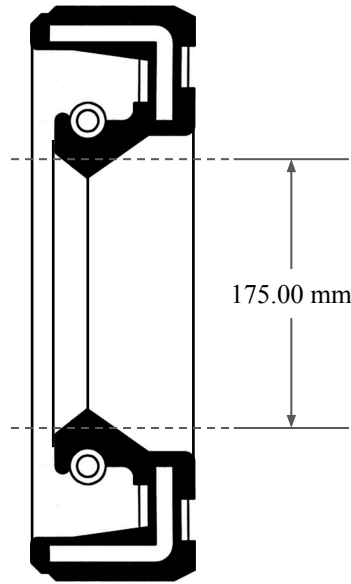

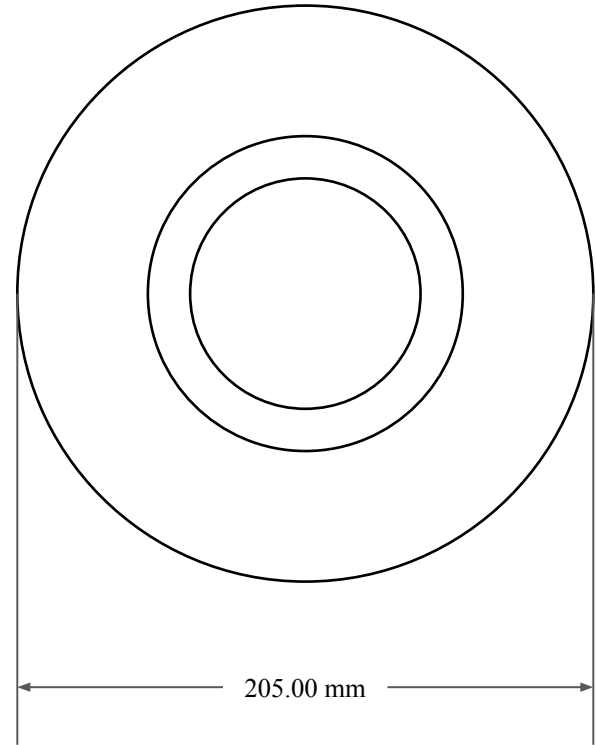

15.00
mm



175.00 mm



205.00 mm

 GLOBAL O-RING and SEAL ALL-AROUND BETTER	PART NUMBER MOS13105SC
14450 John F. Kennedy Blvd. Houston, TX 77032	www.globaloring.com
Information in this drawing is provided for reference only	
Metric Oil Seal - Nitrile Style SC SGL LIP W/ SPR, RBR OD	