

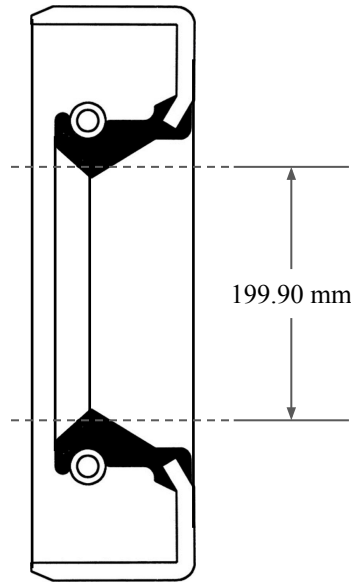

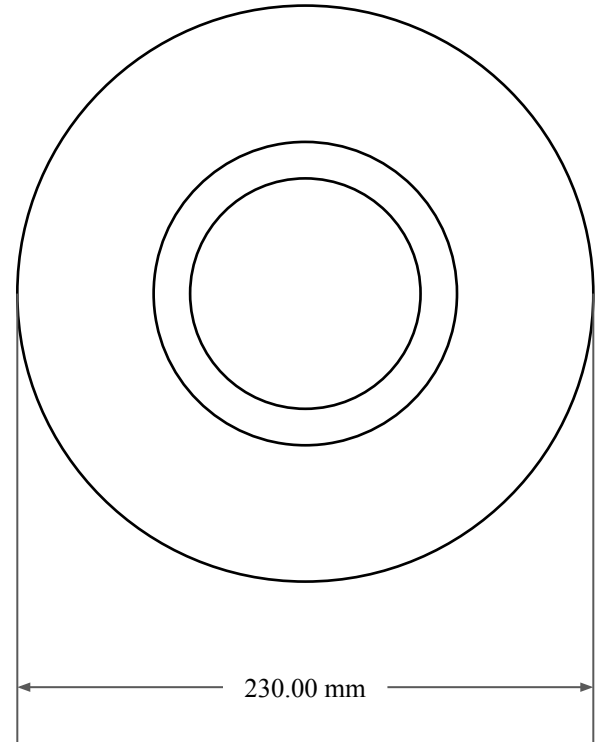

15.00  
mm



199.90 mm



230.00 mm

 <b>GLOBAL O-RING</b> and SEAL ALL-AROUND BETTER	PART NUMBER <b>MOS13318SB2</b>
14450 John F. Kennedy Blvd. Houston, TX 77032	Metric Oil Seal - Nitrile Style SB2 SGL LIP W/ SPR, MTL OD
Information in this drawing is provided for reference only	