

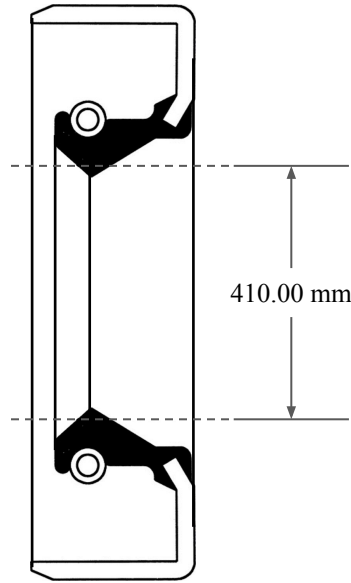

25.00
mm

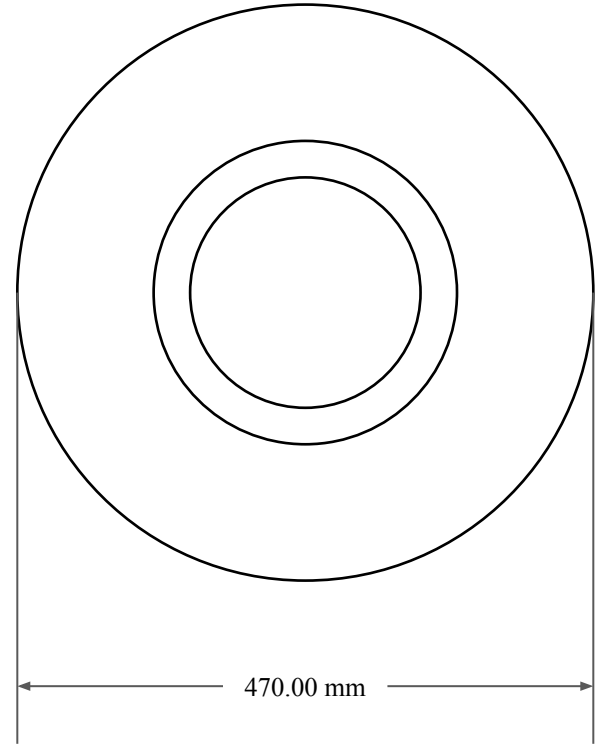

410.00 mm



470.00 mm



14450 John F. Kennedy Blvd.
Houston, TX 77032

www.globaloring.com

PART
NUMBER

MOS14510SB2

Metric Oil Seal - Nitrile Style SB2
SGL LIP W/ SPR, MTL OD

Information in this drawing is provided for reference only